

Compact Disc Changer SL-PD8/SL-PD6/SL-PD5

Operating Instructions

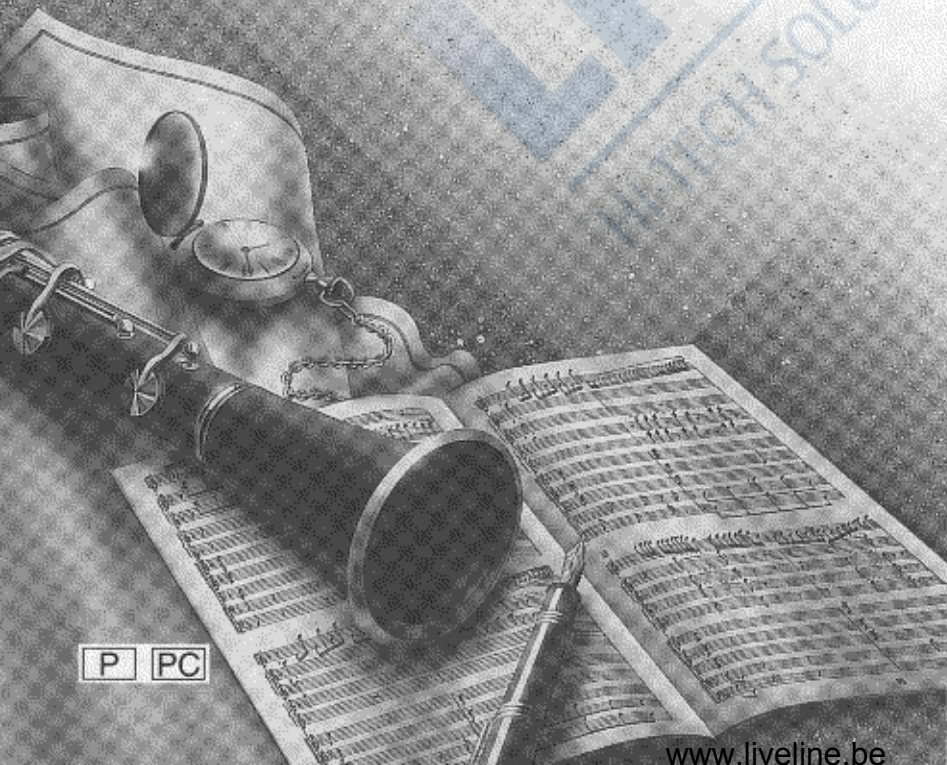

The photograph shows model SL-PD8.



Technics®

Before connecting, operating or adjusting this product, please read these instructions completely. Please save this manual.

P | PC

RQT4751-1P

Supplied accessories

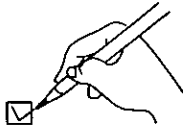

Please check and identify the supplied accessories.

Use numbers indicated in parentheses when asking for replacement parts.

(Only for U.S.A.)

To order accessories contact 1-800-332-5368 or web site (<http://www.panasonic.com>).

- AC power supply cord (RJA0065-A) 1 pc.

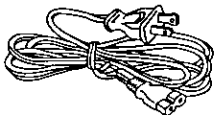

- Stereo connection cable (RJL2P004B08A) 1 pc.

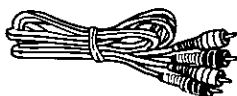

- SL-PD8 only**
Remote control transmitter (RAK-SL948WK) 1 pc.



- SL-PD8 only**
Batteries 2 pcs.

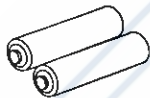

Cautions concerning the moving of this unit

CAUTION

Before moving the changer to another location, be sure to carry out the "Preparations for moving the unit" described below.

Failure to do so will expose the compact discs and the changer to the risk of severe damage.

Preparations for moving the unit

All of the discs must be removed so that the trays are completely empty.

Use the following procedure.

- ① Press [⏻/⏹] to switch off the unit.
- ② Press [⏻/⏹] to switch on the unit.
(If there is a disc in the play section, it will be returned to the disc tray at this time.)
- ③ Press [▲OPEN/CLOSE] to open the loading drawer.
- ④ Press [DISC SKIP] to rotate the disc trays and remove the discs from all disc trays.
- ⑤ Press [▲OPEN/CLOSE] to close the loading drawer.
- ⑥ Press [⏻/⏹] to switch off the unit.

If you have pressed a wrong button by mistake, return to step

①.

Dear customer

Thank you for purchasing this Technics product.

For optimum performance and safety, please read these instructions carefully.

These operating instructions are applicable to the SL-PD8, SL-PD6 and SL-PD5 models.

These operating instructions, however, fundamentally explain the operation of SL-PD8 model.

Table of Contents

Before use

Precautions	4
Connections	5
Preparing the remote control SL-PD8 only	5
Front panel controls	6

Operations

Basic operations	7
Sequential play	7
To directly access a desired track	8
To exchange discs during play	8
Random play	9
One disc random play	9
Full random play	9
Spiral play	9
Program play	10
ID scan function SL-PD8 and SL-PD6 only	11
Search function	11
Skip function	12
To skip discs	12
To skip tracks	12
Repeat function	13
Time mode selection	13
Edit guide function SL-PD8 and SL-PD6 only	14

Reference

Concerning compact discs	15
Technical specifications	15
Troubleshooting guide	Back cover
Product service	Back cover

The model number and serial number of this product can be found on either the back or the bottom of the unit. Please note them in the space provided below and keep for future reference.

MODEL NUMBER _____

SERIAL NUMBER _____

User memo:

DATE OF PURCHASE _____

DEALER NAME _____

DEALER ADDRESS _____

TELEPHONE NUMBER _____

THE FOLLOWING APPLIES ONLY IN THE U.S.A.

CAUTION:

This equipment has been tested and found to comply with the limits for a Class B digital device, pursuant to Part 15 of the FCC Rules. These limits are designed to provide reasonable protection against harmful interference in a residential installation. This equipment generates, uses and can radiate radio frequency energy and, if not installed and used in accordance with the instructions, may cause harmful interference to radio communications. However, there is no guarantee that interference will not occur in a particular installation. If this equipment does cause harmful interference to radio or television reception, which can be determined by turning the equipment off and on, the user is encouraged to try to correct the interference by one of the following measures:

- Reorient or relocate the receiving antenna.
- Increase the separation between the equipment and receiver.
- Connect the equipment into an outlet on a circuit different from that to which the receiver is connected.
- Consult the dealer or an experienced radio/TV technician for help.

Any unauthorized changes or modifications to this equipment would void the user's authority to operate this device.

This device complies with Part 15 of the FCC Rules. Operation is subject to the following two conditions: (1) This device may not cause harmful interference, and (2) this device must accept any interference received, including interference that may cause undesired operation.

CAUTION!

THIS PRODUCT UTILIZES A LASER. USE OF CONTROLS OR ADJUSTMENTS OR PERFORMANCE OF PROCEDURES OTHER THAN THOSE SPECIFIED HEREIN MAY RESULT IN HAZARDOUS RADIATION EXPOSURE.



DO NOT OPEN COVERS AND DO NOT REPAIR YOURSELF. REFER SERVICING TO QUALIFIED PERSONNEL.

CAUTION:

TO PREVENT ELECTRIC SHOCK MATCH WIDE BLADE OF PLUG TO WIDE SLOT, FULLY INSERT.

WARNING:

TO REDUCE THE RISK OF FIRE, ELECTRIC SHOCK OR PRODUCT DAMAGE, DO NOT EXPOSE THIS APPLIANCE TO RAIN, SPLASHING, DRIPPING OR MOISTURE.

	CAUTION RISK OF ELECTRIC SHOCK DO NOT OPEN	
<p>CAUTION: TO REDUCE THE RISK OF ELECTRIC SHOCK, DO NOT REMOVE SCREWS. NO USER-SERVICEABLE PARTS INSIDE. REFER SERVICING TO QUALIFIED SERVICE PERSONNEL.</p>		



The lightning flash with arrowhead symbol, within an equilateral triangle, is intended to alert the user to the presence of uninsulated "dangerous voltage" within the product's enclosure that may be of sufficient magnitude to constitute a risk of electric shock to persons.



The exclamation point within an equilateral triangle is intended to alert the user to the presence of important operating and maintenance (servicing) instructions in the literature accompanying the appliance.

Before using this unit please read these operating instructions carefully. Take special care to follow the warnings indicated on the unit itself as well as the safety suggestions listed below. Afterwards keep them handy for future reference.

Safety

- Power Source**—The unit should be connected to power supply only of the type described in the operating instructions or as marked on the unit.
- Polarization**—If the unit is equipped with a polarized AC power plug (a plug having one blade wider than the other), that plug will fit into the AC outlet only one way. This is a safety feature. If you are unable to insert the plug fully into the outlet, try reversing the plug. If the plug should still fail to fit, contact your electrician to replace your obsolete outlet. Do not defeat the safety purpose of the polarized plug.
- Power Cord Protection**—AC power supply cords should be routed so that they are not likely to be walked on or pinched by items placed upon or against them. Never take hold of the plug or cord if your hand is wet, and always grasp the plug body when connecting or disconnecting it.
- Nonuse Periods**—When the unit is not used, turn the power off. When left unused for a long period of time, the unit should be unplugged from the household AC outlet.

Installation

Environment

- Water and Moisture**—Do not use this unit near water—for example, near a bathtub, washbowl, swimming pool, or the like. Damp basements should also be avoided.
- Condensation**—Moisture may form on the lens in the following conditions...
 - immediately after a heater has been turned on.
 - in a steamy or very humid room.
 - when the unit is suddenly moved from a cold environment to a warm one.
 If moisture forms inside this unit, it may not operate properly. To correct this problem, turn on the power and wait about one hour for the moisture to evaporate.
- Heat**—The unit should be situated away from heat sources such as radiators and the like. It also should not be placed in temperatures less than 5°C (41°F) or greater than 35°C (95°F).

Placement

- Ventilation**—The unit should be situated so that its location or position does not interfere with its proper ventilation. Allow 10 cm (4") clearance from the rear of the unit.
- Foreign Material**—Care should be taken so that objects do not fall into and liquids are not spilled into the unit. Do not subject this unit to excessive smoke, dust, mechanical vibration, or shock.
- Magnetism**—The unit should be situated away from equipment or devices that generate strong magnetic fields.
- Stacking**—Do not place heavy objects, other than system components, on top of the unit.
- Surface**—Place the unit on a flat, level surface.
- Carts and Stands**—The unit should be used only with a cart or stand that is recommended by the manufacturer. The unit and cart combination should be moved with care. Quick stops, excessive force, and uneven surfaces may cause the unit and cart combination to overturn.
- Wall or Ceiling Mounting**—The unit should not be mounted to a wall or ceiling, unless specified in this operating instructions.



Maintenance

Clean the cabinet, panel and controls with a soft cloth lightly moistened with mild detergent solution. Do not use any type of abrasive pad, scouring powder or solvent such as alcohol or benzine.

Service

- Damage Requiring Service**—The unit should be serviced by qualified service personnel when:
 - The AC power supply cord or the plug has been damaged; or
 - Objects have fallen or liquid has been spilled into the unit; or
 - The unit has been exposed to rain; or
 - The unit does not appear to operate normally or exhibits a marked change in performance; or
 - The unit has been dropped, or the enclosure damaged.
- Servicing**—The user should not attempt to service the unit beyond that described in the operating instructions. All other servicing should be referred to an authorized service personnel.
For the address of an authorized servicenter:
In the U.S.A. 1-800-211-7262 or web site
(<http://www.panasonic.com>)
In Canada 905-624-5505 or web site
(www.panasonic.ca/fdbckca.htm)

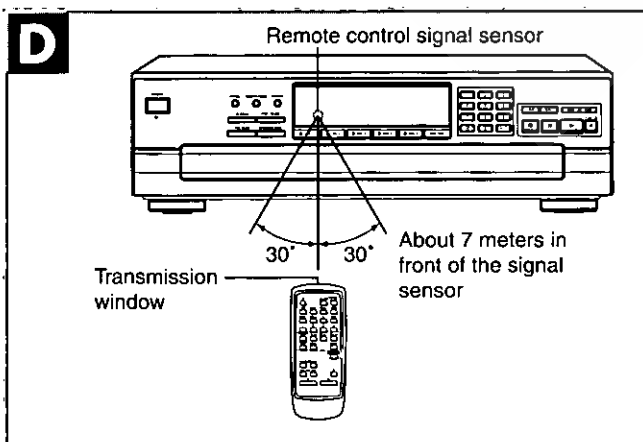
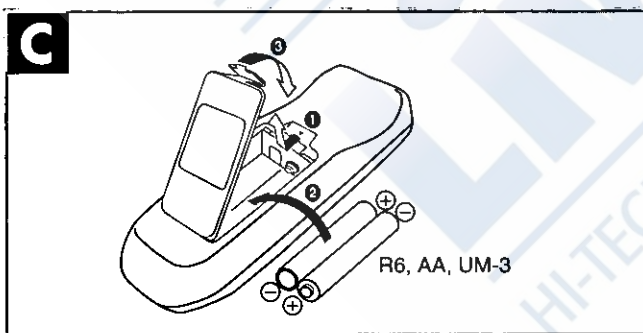
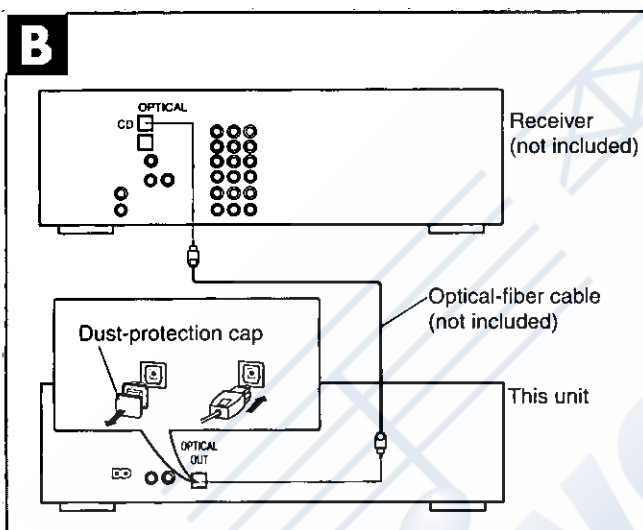
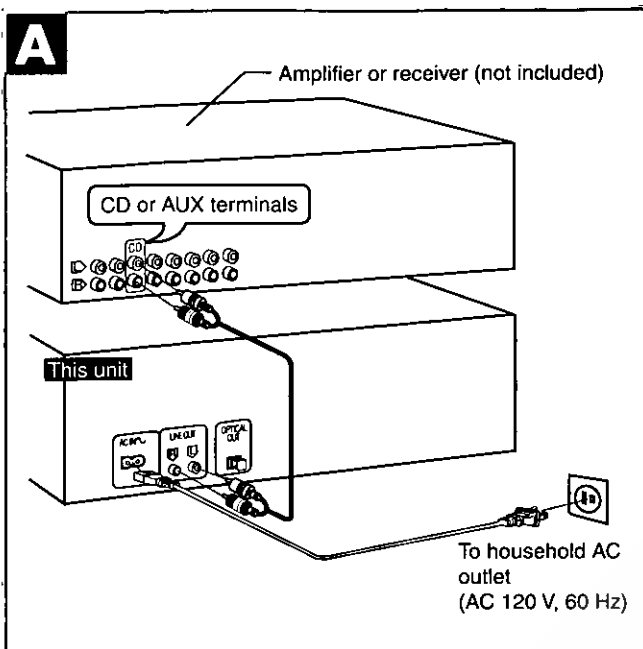

Before making connections, be sure that the power of this unit and all other system components is turned off. **A**

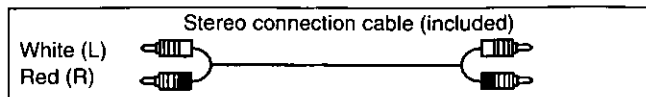

Note

Although the figure shows the AC power supply cord being connected to a household AC outlet, if the amplifier (or receiver) is equipped with a AC outlet, connect the cord to that outlet.

Digital connection B

Remove the dust-protection cap and connect this unit to other digital equipment with an optical fiber terminal, such as a receiver or digital surround processor.

- Leave the cap attached when this terminal is not being used.

For your reference

If you have DTS format CDs, you can enjoy six channel playback by connecting this unit to a receiver or digital surround processor that has a DTS decoder.

Note

Use only the optical fiber terminal when playing back DTS format discs. DTS signals can only be correctly output through the digital terminal. Connection through the stereo LINE OUT terminals will result in noise and could possibly damage your speakers.

- DTS is a trademark of Digital Theater Systems, L.P.

Preparing the remote control

SL-PD8 only

Battery installation

Check the (+) and (-) sides.

Use of batteries

- Do not mix old and new batteries, or batteries of different types (manganese and alkaline, etc.).
- Never subject batteries to excessive heat or flame; do not attempt to disassemble them; and be sure they are not short-circuited.
- If the remote control is not to be used for a long period of time, remove the batteries and store them in a cool, dark place.
- Do not attempt to recharge alkaline or manganese batteries.
- Do not use rechargeable type batteries.

When you need to replace these batteries

Use two R6, AA, UM-3 or equivalent batteries.

Correct method of use

Use the remote control within 60 degrees and within 7 meters (23 ft.) facing toward the unit.

Operation notes

- Aim the remote control's transmission window toward the unit's sensor. Avoid any obstacles.
- Be sure the transmission window and the unit's sensor are free from dust. Excessive dust might affect performance.
- Do not expose the remote control signal sensor to direct sunlight or to the bright light of an inverter fluorescent light.

To prevent damage

- Never place heavy items on top of the unit.
- Do not disassemble or reconstruct the unit.
- Do not spill water or other liquids into the unit.

A

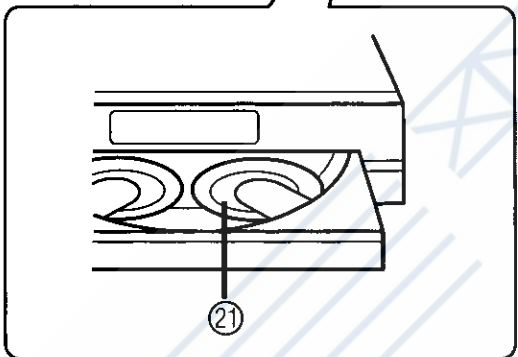
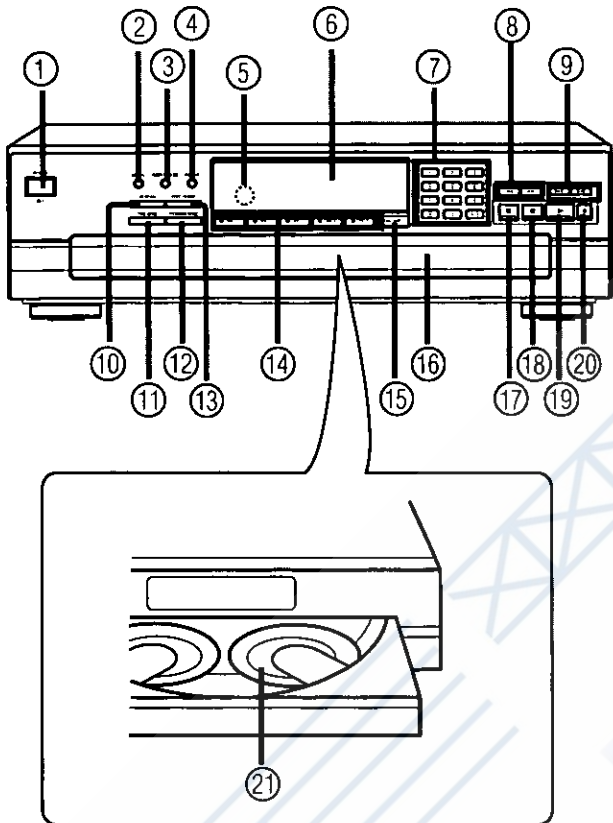

B

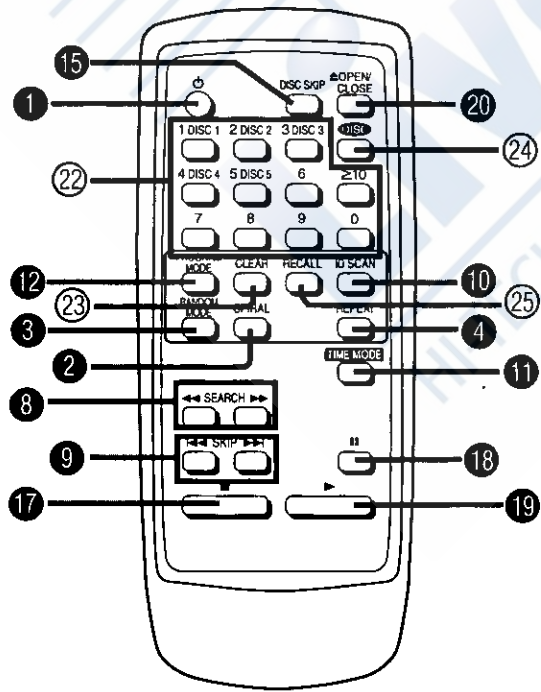

Main unit

No.	Name	Ref.page
①	Standby/on switch (⏻/I, POWER).....	7
	Press to switch the unit from on to standby mode or vice versa. In standby mode, the unit is still consuming a small amount of power.	
②	Spiral button (SPIRAL).....	9
③	Random mode button (RANDOM MODE).....	9
④	Repeat button (REPEAT).....	13
⑤	Remote control signal sensor.....	5
	This changer can be operated by using the remote control provided with a Technics receiver. (This may not be possible with some models.)	
⑥	Display	
⑦	Numeric buttons (1-10, 0, >10).....	8
⑧	Search buttons (◀, ▶).....	11
⑨	Skip buttons (◀◀, ▶▶).....	12
⑩	SL-PD8 and SL-PD6 only ID scan button (ID SCAN).....	11
⑪	Time mode button (TIME MODE).....	13
⑫	Program mode button (PROGRAM MODE).....	10
⑬	SL-PD8 and SL-PD6 only Edit guide button (EDIT GUIDE).....	14
⑭	Disc buttons (DISC 1-DISC 5).....	7
⑮	Disc skip button (DISC SKIP).....	7, 12
⑯	Loading drawer.....	7
⑰	Stop button (■).....	8
⑱	Pause button ().....	8
⑲	Play button (▶).....	8
⑳	Loading drawer open/close button (▲OPEN/CLOSE).....	7
㉑	Disc trays (1-5).....	7

Remote control SL-PD8 only

Buttons ①, ②, ③, ④, ⑥, ⑨, ⑩, ⑪, ⑫, ⑮, ⑰, ⑱, ⑲ and ㉑ have the same functions as the corresponding buttons on the main unit.

No.	Name	Ref.page
㉒	Numeric buttons.....	8
㉓	Clear button (CLEAR).....	11
㉔	Disc button (DISC).....	7
㉕	Recall button (RECALL).....	11

Before use

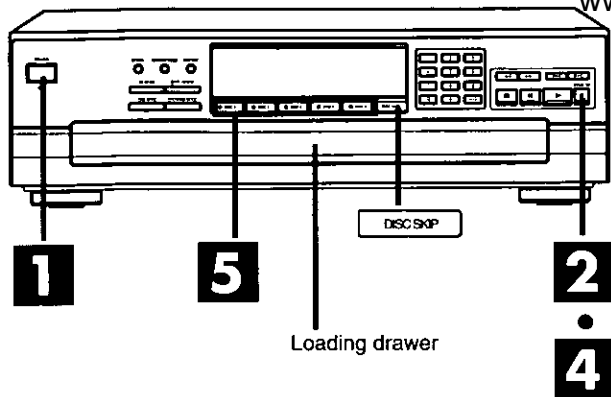

Sequential play

All of the discs will be played, beginning from track 1 on the selected disc.

The explanation below is an example of operation in the case where all five disc trays in the changer are holding CDs.

- 1** Press [POWER].
The unit will switch on.
- 2** Press [OPEN/CLOSE] to open the loading drawer.
- 3** Load the disc(s) on the disc tray(s).
The discs can be loaded two at a time by pressing [DISC SKIP] to rotate the carousel.

Note

- Do not load 3"(8 cm) and 5"(12 cm) discs on the same disc tray.
- Do not use irregular shape CDs. (See page 15.)

CAUTION

Do not touch the loading drawer and carousel while they are in motion, and do not attempt to rotate the carousel by hand; doing so could result in incorrect operation of the unit and/or damage to the discs.

- 4** Press [OPEN/CLOSE] again to close the loading drawer.

Note

Do not attempt to close the drawer by hand.

- 5** Press the desired disc button ([DISC 1]-[DISC 5]).
Play will begin from the selected disc. If a disc is not on the selected disc tray, the changer plays the disc at the next number.

SL-PD8 only

The disc indicator lights when there is a disc in the corresponding tray.

For remote control SL-PD8 only

Press [DISC] and then within 7 seconds or so, press [DISC 1]-[DISC 5] to select the disc you want.

The changer plays all the tracks on all the discs in order and stops automatically when the last track on the last disc finishes playing. The first disc will then be at the playing position.

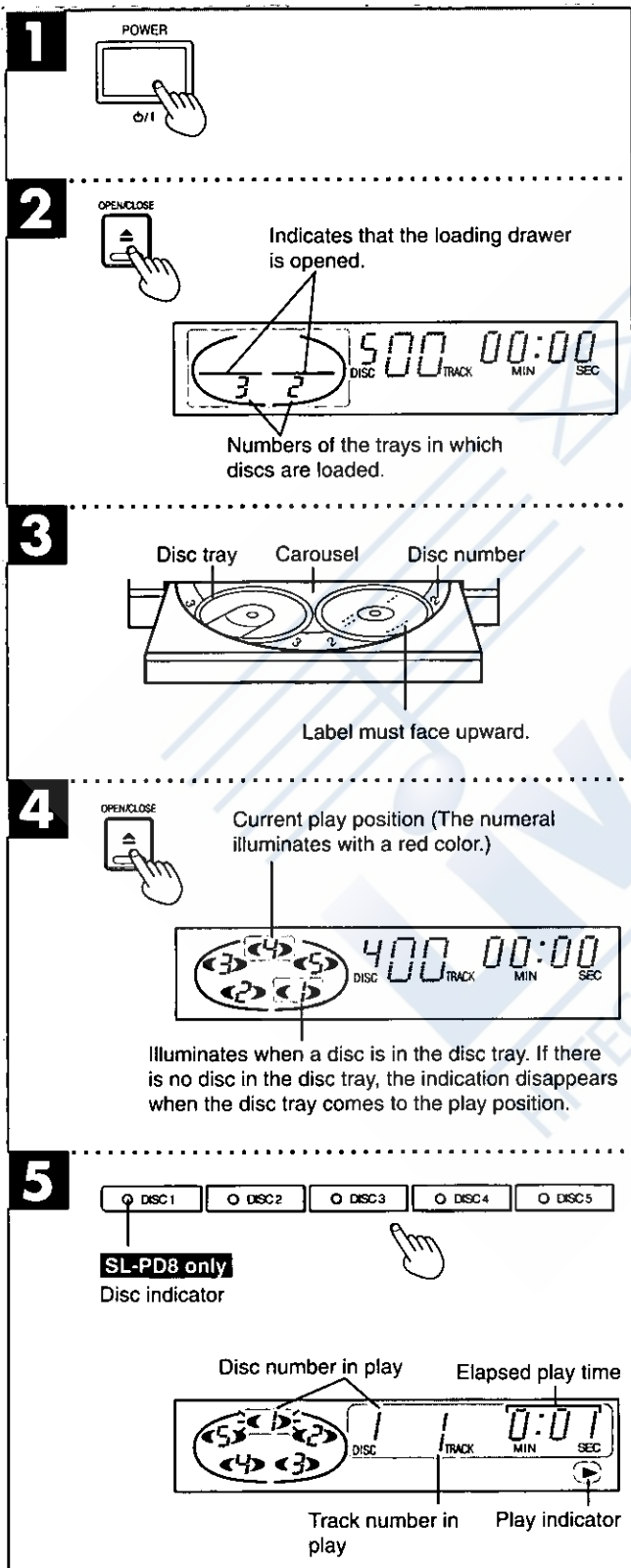

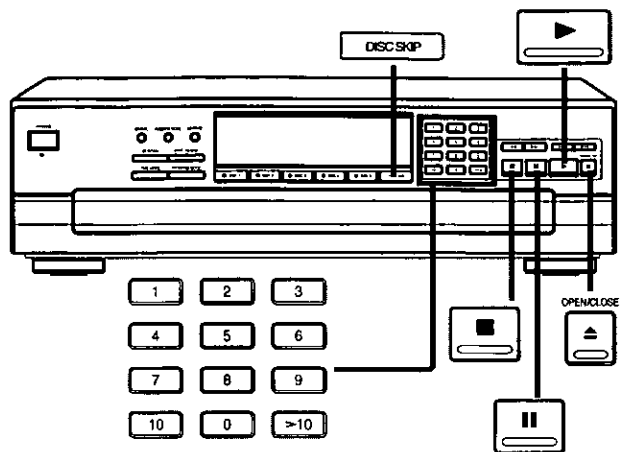

To directly access a desired track **A**

Press the numeric button(s) to select the track.

To select a two-digit track number over 10
(or to select a two-digit track from the remote control for SL-PD8)

Press [>10] (≥ 10) on the remote control for SL-PD8) and then the two numbers you want within 7 seconds or so.

For example

Track no. 20: [>10] (≥ 10) on the remote control for SL-PD8)

[2] → [0]

To exchange discs during play **B**

While playing a disc, it is possible to change the other discs without interrupting play.

① Press [Δ OPEN/CLOSE] to open the loading drawer.

② Press [DISC SKIP] to rotate the disc trays and exchange the discs.

The carousel will move by one disc tray. Pressing again moves the carousel in the opposite direction by two disc trays.

③ Press [Δ OPEN/CLOSE] to close the loading drawer.

Note

If you play a disc with the loading drawer open, discs other than the current disc cannot be played.

To temporarily stop play **C**

Press [II].

Press [▶] to resume play.

To stop play **D**

Press [■].

The display will show the total number of tracks and the total playing time of the current disc.

The total playing time displayed includes the silent sections between tracks. For this reason, it may be a few seconds longer than the playing time indicated on the disc.

Press [▶] to re-start play.

CAUTION

Do not move this changer with a compact disc inside the unit. If a disc comes off the disc tray, it might be scratched or the changer might become incapable of playing.
(Refer to "Cautions concerning the moving of this unit" on page 2.)

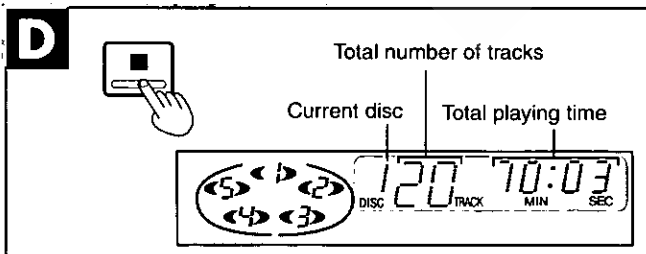
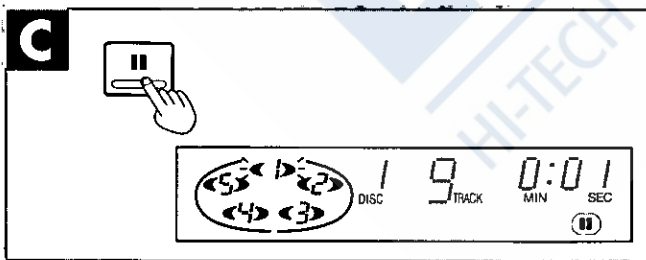
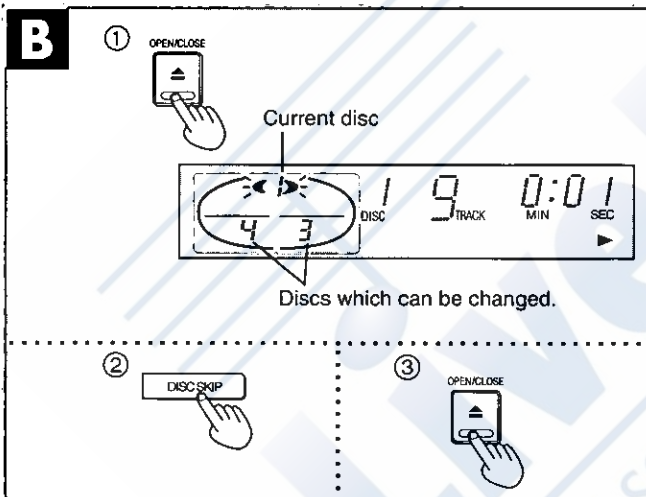
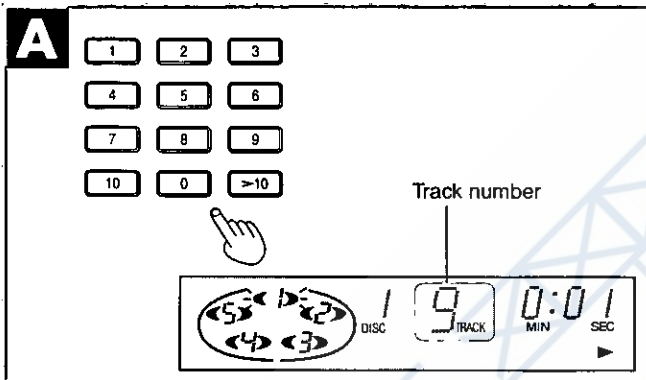

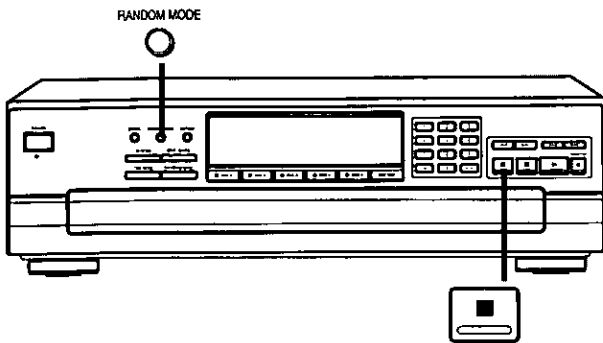

All of the tracks will be played one time each in random order. There are two types of random play as described below.

One disc random play

The changer will play all tracks on the current disc in a random order. Then it will choose a new disc randomly, excluding the discs already played, and play all tracks on that disc in a random order.

In the stop or play mode

Press [RANDOM MODE] so that the "1 DISC RND" indicator illuminates.

Every time you press the button:

1 DISC RND → FULL RND → (off)

Full random play

Each track to be played back is selected randomly from all of the tracks on all of the discs, excluding the tracks that have already been played.

In the stop or play mode

Press [RANDOM MODE] so that the "FULL RND" indicator illuminates.

Every time you press the button:

1 DISC RND → FULL RND → (off)

The changer will stop automatically when all the tracks on all discs have been played once.

To cancel random play mode

Press [■].

The "1 DISC (or FULL) RND" indicator will go out.

Spiral play

The changer plays the first tracks on all the loaded discs in sequence, followed by the second tracks on all the discs, and so on.

In the stop or play mode

Press [SPIRAL].

Spiral play will begin with the first track on the disc situated at the playing position.

The changer will stop automatically when all the tracks on all discs have been played once.

For your reference

When a disc with fewer tracks finishes playing, that disc will be skipped and the changer will continue playing the remaining track on the other discs in spiral sequence.

To cancel spiral play mode

Press [SPIRAL] again.

The "SPIRAL" indicator will go out.

The changer will return to sequential play mode from the current track on the current disc which is playing.

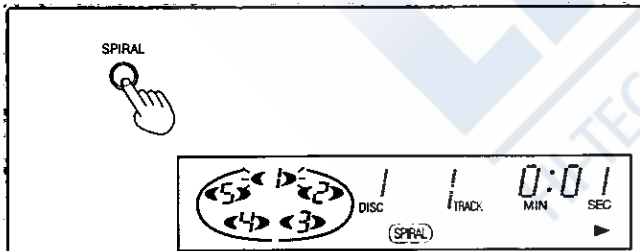
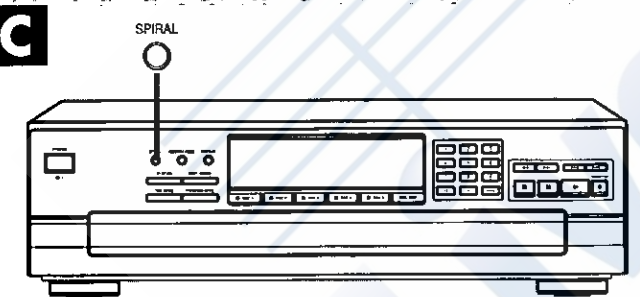
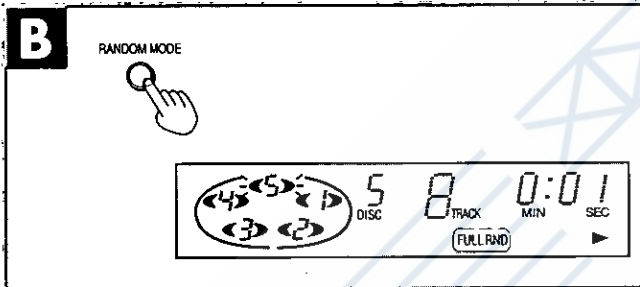
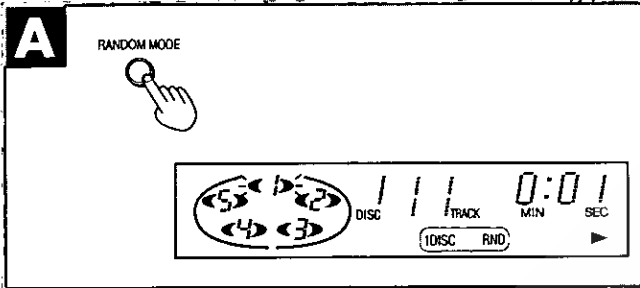

Example: When starting from disc 1

Spiral play

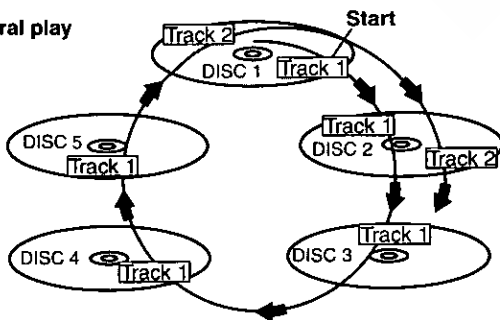

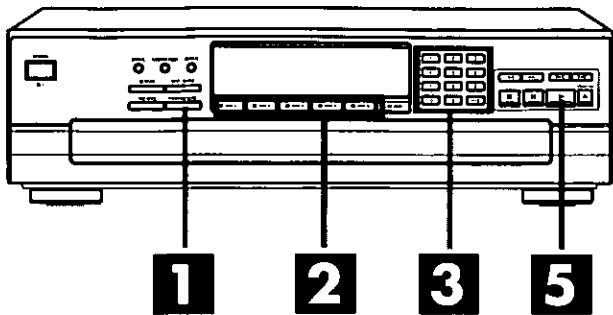

1 **PROGRAM MODE**

2

Specified disc number

3

Specified track number

Program order

5

This unit has two program play modes; program (PGM) and delete (DEL).

Program mode allows you to select and play your favorite tracks in the order you want to hear them.

Delete mode allows you to program the unit not to play certain tracks. This mode can be used in combination with sequential and random play.

Up to 32 tracks can be selected for each mode.

1 While the unit is stopped
Select the mode with [PROGRAM MODE].
 Every time you press the button:
 PGM → DEL → (off)

2 Press [DISC (1 to 5)] to select the required disc.
 "AL" appears on the display to indicate all the tracks on the disc are selected.
 Repeat the above if you want to make selection by disc only.
 The number of programmed items increases by one each time a [DISC] button is pressed.

3 Press the numeric button(s) to select a track.
To select a two-digit track number over 10 (or to select a two-digit track from the remote control for SL-PD8)
 Press [>10] ([≥10] on the remote control for SL-PD8) and then the two numbers you want within 7 seconds or so.
For example
 Track no. 20: [>10] ([≥10] on the remote control for SL-PD8)
 ↓
 [2] → [0]

4 Repeat steps **2** and **3** to complete the selection.
 If a non-existing disc or track number is entered, the selection is initially recorded but erased automatically during playback.
 "F" is displayed if you attempt to enter a 33rd item.

5 Press [▶] to start play.
 Additional selections can be made during play by repeating steps **2** and **3**.

To use random play and delete mode together
 After step **4**, make your random play mode selection (see page 9).

To cancel program play
 While the unit is stopped
Press [PROGRAM MODE] to select "(off)" mode.

The contents of the program remain in the unit's memory even after the unit is turned off.

To use the program again
 1. Press [PROGRAM MODE] to select the required mode.
 2. Press [▶].

For your reference
 The program remains in the memory for up to two weeks even if the unit is disconnected from its power source.

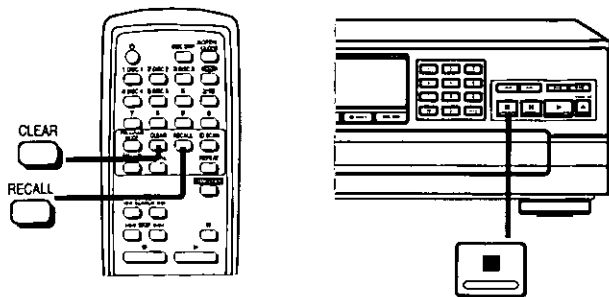

SL-PD8 only (Remote control only)

To confirm the selections A

Press [RECALL].

Each time you press the button, the tracks and discs you programmed appear on the display in the order they were selected.

To cancel selections

While the unit is stopped

Press [■]. The entire program is cancelled.

SL-PD8 only (Remote control only)

To clear the last item in the program B

Press [CLEAR].

To clear a specific item

1. Press [RECALL] until the item is displayed.
2. Press [CLEAR].

ID scan function □

SL-PD8 and SL-PD6 only

This function is convenient to use when searching for a desired track.

The function will search from the beginning of the track for a loud section, and will play 10 seconds of the track centering around that point.

The order of scanning is the same as for play mode.

1 Press [ID SCAN].

ID scan will start.

2 When the desired track has been found:

Press [▶].

The changer will play the track from the beginning.

To cancel ID scan

Press [ID SCAN].

The "ID" indicator will go out.

The changer will continue to play from the track being played.

Search function □

You can search rapidly forward or backward on the disc for specific sections.

In the play or pause mode

Press and hold [◀◀] or [▶▶].

[◀◀]: You can search backward.

[▶▶]: You can search forward.

Release the button when you reach the desired point.

The changer will return to the previous mode (play or pause).

In sequential play mode

You can search forward over discs and backward within the current disc.

In other play modes

You can search forward or backward only within the current track.

For your reference

The search function will begin slowly, and then, if the button is held pressed for longer than 3 seconds, it will change to high-speed search.

Searching in the play mode will decrease the sound level by 12 dB (1/4).

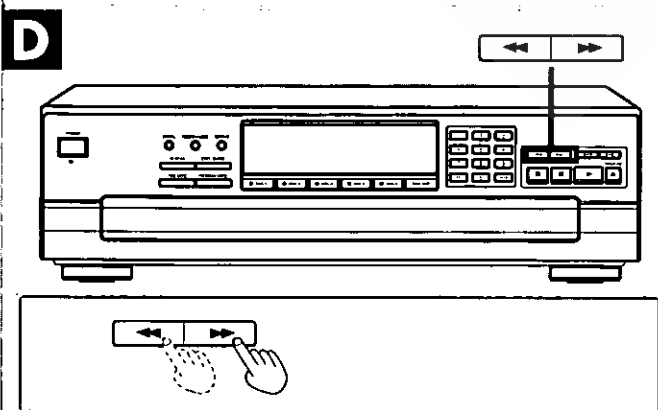
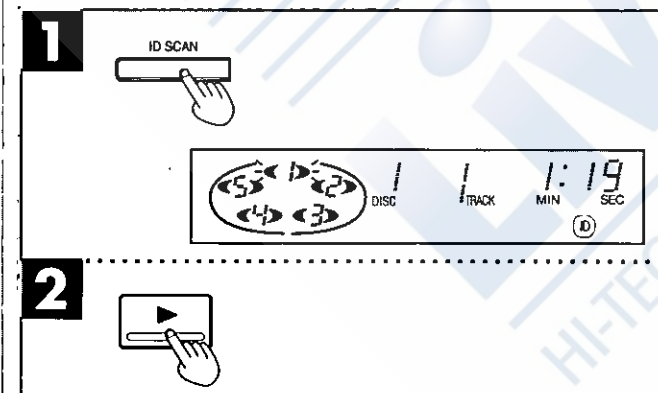
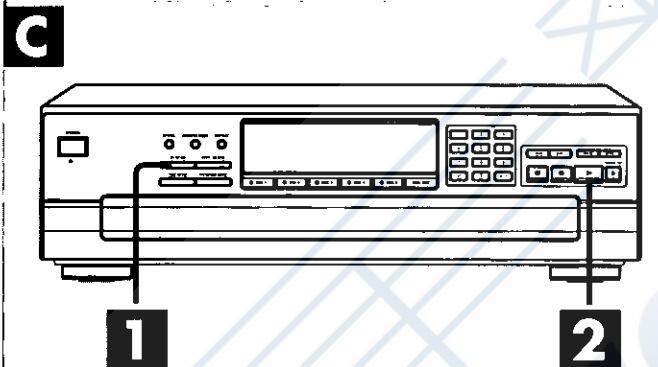
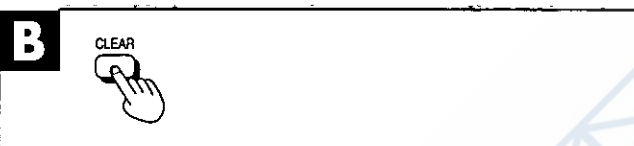
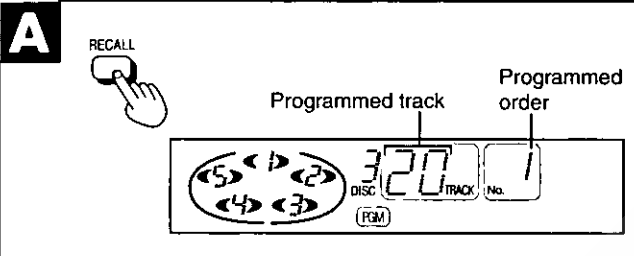

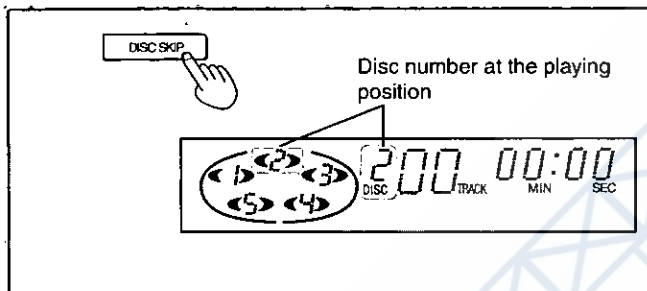
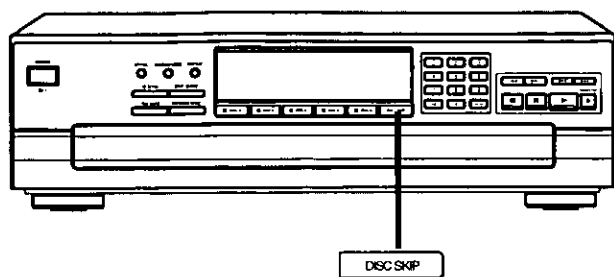
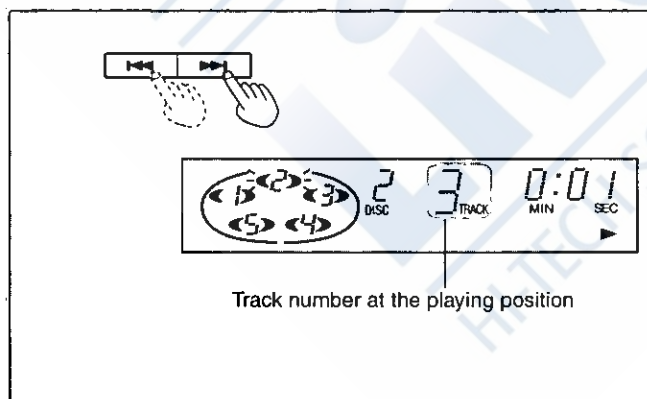
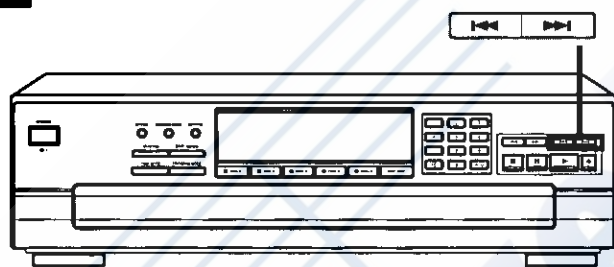
A**B****To skip discs****A**

Use this function to skip discs when selecting a disc to which you wish to listen, and when loading and unloading the discs.

You can use this function in stop, sequential play, one disc random play and delete play modes.

Press [DISC SKIP] to rotate the disc tray.

In stop mode

When the loading drawer is closed, pressing [DISC SKIP] changes the disc tray to the next one.

When the loading drawer is open, pressing [DISC SKIP] moves the carousel by two disc trays.

In play mode

When the loading drawer is closed, pressing [DISC SKIP] changes the disc and the changer plays the track on the next disc.

If a disc is not on the selected disc tray, the changer plays the disc at the next number.

When the loading drawer is open, pressing [DISC SKIP] moves the carousel by one disc tray. Pressing again moves the carousel in the opposite direction so that you can change all discs except the one being played.

To skip tracks**B**

Use this function to skip tracks when selecting a track to which you wish to listen.

Press either [◀◀] or [▶▶] until you reach the desired track.

[◀◀]: You can skip backward.

[▶▶]: You can skip forward.

In sequential/program /delete play mode

In sequential play mode, you can skip only within the current disc.

In program play mode, you can skip from one track to another in the programmed sequence.

In delete play mode, you can skip tracks only within the current disc excluding the tracks to be deleted.

[◀◀]: You can skip to the beginning of the track being played. If you press this button again quickly, you can skip to the beginning of the previous track.

Remember that in a backward skip, the current track is included in the count.

[▶▶]: You can skip as many tracks as the number of times you press the button.

In random play mode

[◀◀]: You can skip to the beginning of the current track.

[▶▶]: You can skip to the beginning of a next track in random order.

In spiral play mode

[◀◀]: You can skip to the beginning of the current track.

[▶▶]: You can skip to the beginning of the track on the next disc.

You can also skip tracks when the changer is in the stop mode (except during random play and spiral play) or pause mode.

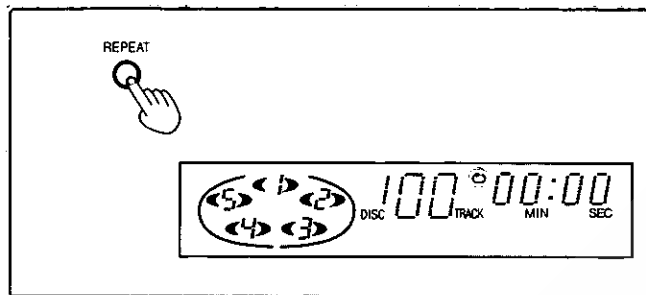
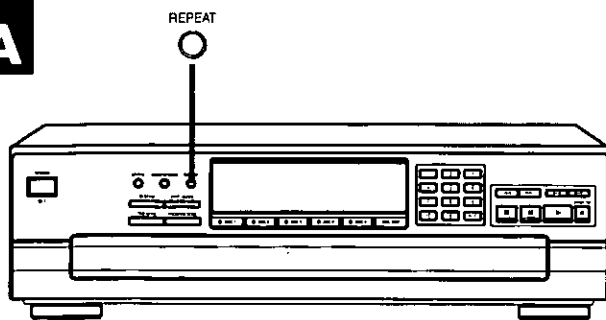
A

Play will continue endlessly in accordance with the specific play mode selected.

Before or during play
Press **[REPEAT]**.

In sequential play mode

All tracks of all discs will be played repeatedly.

In program play mode

The changer plays only the programmed selections in the programmed sequence repeatedly.

In delete play mode

The changer plays the discs and tracks excluding the selections to be deleted repeatedly.

In random play mode

When the changer has played all the tracks on all the loaded discs, it will select a new random sequence and play continuously. The sequence differs each time.

In spiral play mode

The changer plays all tracks of all discs repeatedly in the sequence of spiral play.

To cancel repeat mode

Press **[REPEAT]** again.

The "⏮" indicator will go out.

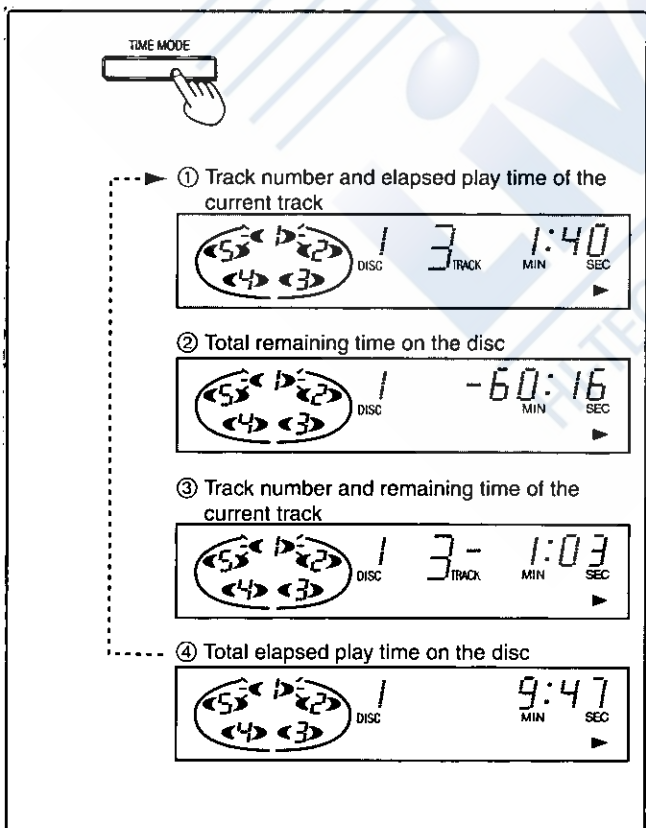
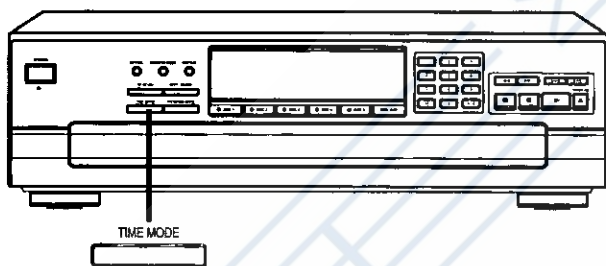
B

Time mode selection **B**

The various time information of the current disc can be displayed.

In the play or pause mode

Press **[TIME MODE]**.

The display changes in the order shown in the diagram.

In all play modes

When track number 21 or greater is playing, display ③ shows "----:--".

① is displayed if play is stopped and then started again.

In program/delete/random/spiral mode

The displayed information will alternate between displays ① and ③ each time the button is pressed.

During operation of the edit guide function

The remaining play time on side A or side B will be shown in display ②, and the elapsed play time for side A or side B will be shown in display ④.

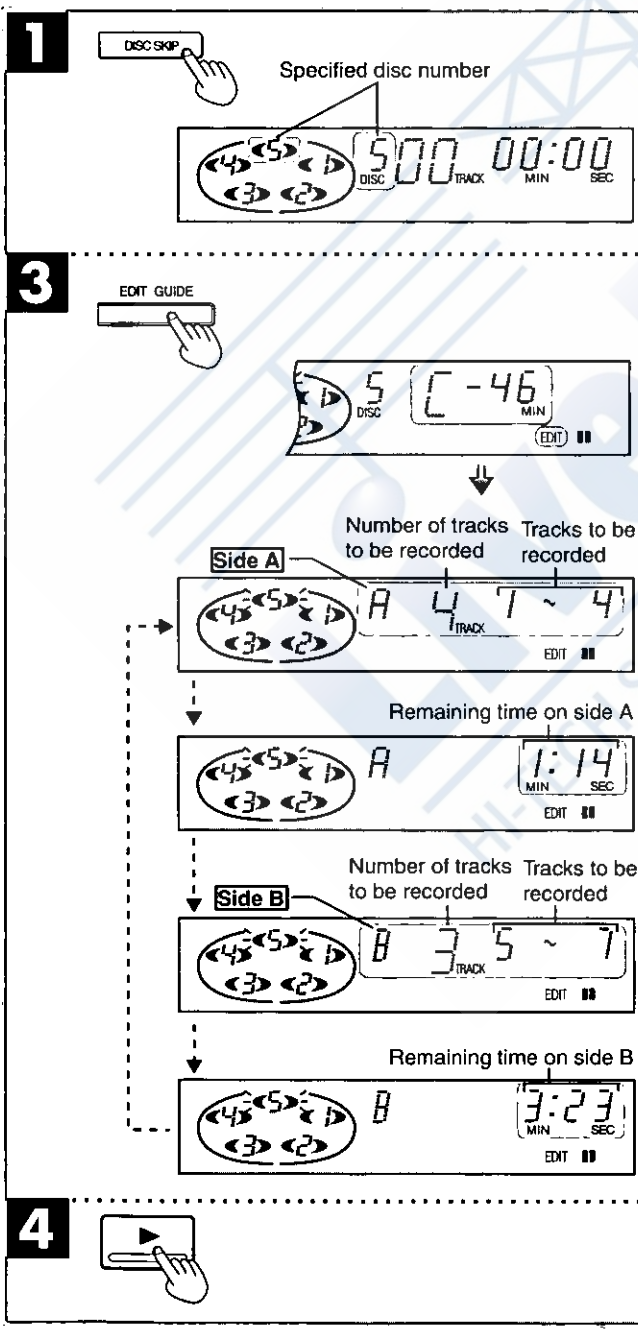
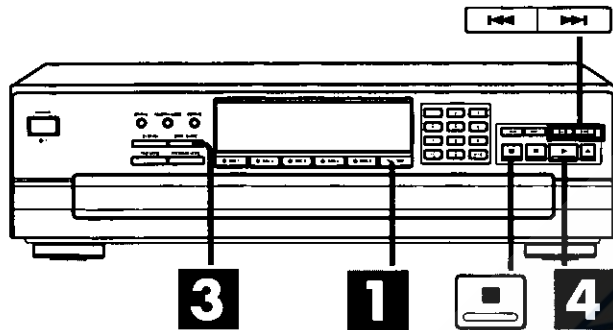
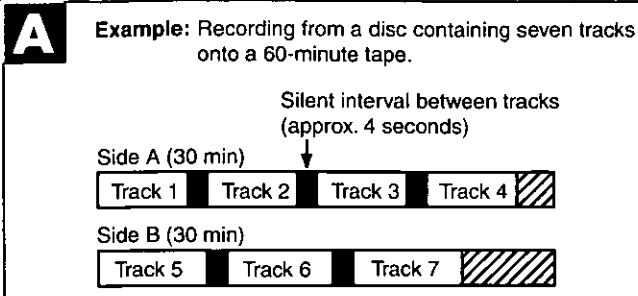

When recording, the changer will automatically program the tracks for tape sides A and B in accordance with the length of the tape so that none of the tracks will be interrupted before they are completed.

In addition, the program will also include a silent interval of approximately 4 seconds between tracks. **A**

1 Press [DISC SKIP] to select the disc to be recorded.

2 Prepare the tape deck for recording.

Set the Dolby NR, reverse mode, recording level, etc., as instructed in the Operating Instructions for the tape deck.

Note

Rewind the tape so recording is possible from its beginning.

3 Press [EDIT GUIDE] to select the tape length.

Each time you press the button, the display showing the tape length changes as follows.

C-46 → C-60 → C-90 → C---

Choose the length of the tape you will use.

More precise time settings are also possible.

(Refer to "To enter a desired recording time other than 46, 60 or 90 minutes" below.)

The data of the tracks to be recorded is displayed as shown in the diagram.

In this example, disc 5 can be recorded with tracks 1-4 on side A and tracks 5-7 on side B of the cassette tape.

4 Start recording on the tape deck and then immediately:

Press [▶].

When the last track set for recording on side A is finished, the changer will enter the pause mode. Set the tape to the position from which recording will begin on side B, and then perform step 4 once again.

When all the programmed tracks on the specified disc finish playing, the changer will automatically stop. The edit guide mode will be cancelled at the same time.

To enter a desired recording time other than 46, 60 or 90 minutes

1. Select "C---" in step **3**.
2. Enter the total recording time in minutes (1-99) using the numeric buttons.

For example

To use 52-minute tape, press [5] then [2].

You can also specify the tape length by pressing [◀◀] or [▶▶] buttons.

Press either [◀◀] or [▶▶] from each step C-46, C-60, C-90 or C---

For example

To use 52-minute tape, select C-46 and then press and hold [▶▶] until the display shows "52".

The maximum allowable playing time for editing is 99 minutes.

To stop recording

Press [■] and then press the stop button on the tape deck.

Note

Depending on the disc, a little of the beginning of the next track may be recorded onto the end of the track.

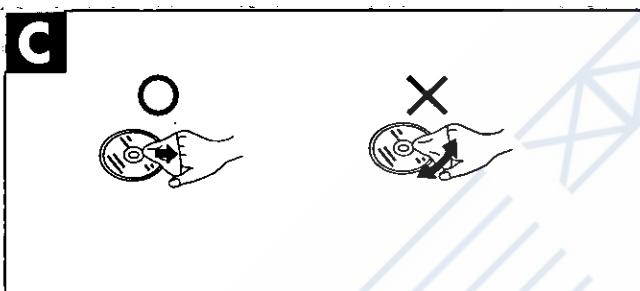
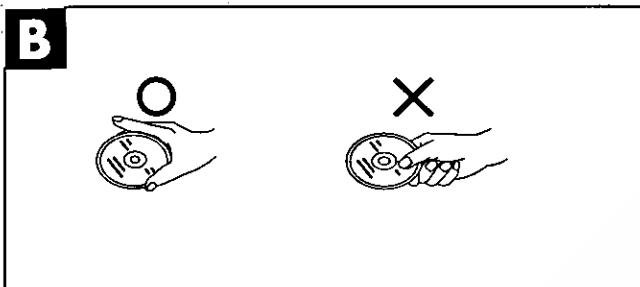
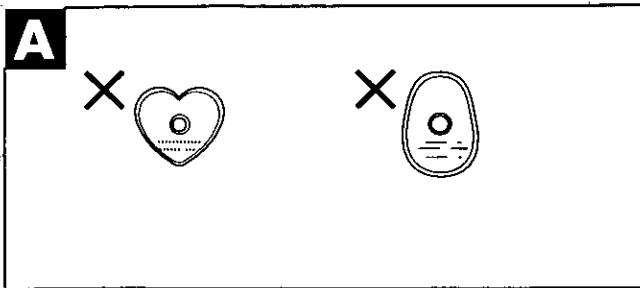

With this changer, you can only play compact discs having this mark.



However, do not use irregular shape CDs. CDs of the sort can damage the unit. **A**

Handling precautions

Handle CDs as shown on the left (**B-C**).

- If you are taking the disc from a cold to a warm environment, moisture may form on the disc. Wipe this off with a soft, dry, lint-free cloth before using the disc.
- Do not write on the label side with a ball-point pen or other writing instrument.
- Do not use record cleaning sprays, benzene, thinner, static electricity prevention liquids or any other solvent.
- Do not use discs with poorly attached labels or stickers. Adhesive protruding from peeled off stickers can cause the changer to malfunction.

Storage precautions

Be sure to store discs in their cases to protect them from dust, scratches, and warping.

Do not place or store discs in the following places:

- Locations exposed to direct sunlight
- Humid or dusty locations
- Locations directly exposed to a heat vent or heating appliance
- In the glove compartment or on the rear deck of an automobile

Technical specifications

AUDIO

No. of channels	2 (left and right, stereo)
Frequency response	2-20000 Hz, ± 1 dB
Output voltage	2 V (at 0 dB)
Dynamic range	92 dB
S/N	100 dB
Total harmonic distortion	0.007% (1 kHz, 0 dB)
Wow and flutter	Below measurable limit
DA converter	MASH (1 bit)
Output impedance	Approx. 1 k Ω
Load impedance	More than 10 k Ω

PICKUP

Wavelength	780 nm
------------	--------

GENERAL

Power supply	AC 120 V, 60 Hz
Power consumption	9 W
Dimensions (W×H×D)	430×125×374 mm (16 ¹⁵ / ₁₆ "×4 ²⁹ / ₃₂ "×14 ²³ / ₃₂ "
Weight	4.5 kg (9.9 lb.)

Note

Specifications are subject to change without notice.
Weight and dimensions are approximate.

Before requesting service for this unit, check the chart below for a possible cause of the problem you are experiencing. Some simple checks or a minor adjustment on your part may eliminate the problem and restore proper operation.

If you are in doubt about some of the check points, or if the remedies indicated in the chart do not solve the problem, refer to the directory of Authorized Service Centers (enclosed with this unit) to locate a convenient service center, or consult your Technics dealer for instructions.

For detailed instructions, contact an authorized servicenter in the U.S.A. and Panasonic Canada Inc. Customer Care Centre in Canada.

In the U.S.A. 1-800-211-7262 or web site (<http://www.panasonic.com>)

In Canada 905-624-5505 or web site (www.panasonic.ca/faq.html)

Problem	Probable cause(s)	Suggested remedy	Reference page(s)
Changer does not play.	A disc(s) or other foreign object(s) has fallen inside the changer.	Open the loading drawer, and then remove the object.	
	Moisture has collected in the changer.	Allow the changer to dry out for about one hour before using it.	
The disc in the changer does not play.	The disc is upside down.	Make sure the label is facing upward.	7
	The disc is dirty.	Wipe the disc with a soft cloth.	15
	The disc is scratched.	Replace the disc with a new one.	
	The disc is warped.		
	The disc is not within specified standards.		
Play stops before changing to the next disc.	The loading drawer is open.	Press the [▲OPEN/CLOSE] button to close the loading drawer.	
A certain music passage can't be played correctly.	The disc is dirty.	Wipe the disc with a soft cloth.	15
	The disc is scratched.	Replace the disc with a new one.	
There is noise from the tuner or disturbance on the TV screen.	Caused by high-frequency signals from this changer.	Use the changer further away from the tuner or TV. If the tuner or TV's antenna is the indoor type, use an outdoor one.	
When program play is started, an error message (-E) appears on the display.	Play was started without a track being programmed.	Program a track.	10
An error message (-E) appears on the display, and the changer stops operating.	The mechanism of the changer has been improperly adjusted.	Turn the unit off and then back on again. However, if the loading drawer is fully open, take out the compact disc(s) at the front position and then turn the unit off and then back on again.	
The loading drawer stops in the middle of opening.			
SL-PD8 only The changer does not respond correctly to remote commands.	The batteries have run out.	Replace batteries with new ones.	5
	There is an obstruction between the remote control and the changer.	Remove the obstruction.	5
	The batteries are inserted incorrectly. The (+) and (-) polarities are reversed.	Reinsert batteries so that the polarities are correct.	5

Product service

Do not attempt to remove the cover(s) or repair the unit yourself. Refer servicing to qualified personnel only.

Product information

For product service, product information or assistance with product operation, refer to the servicenter directory.

Panasonic Consumer Electronics Company, Division of Matsushita Electric Corporation of America
One Panasonic Way Secaucus, New Jersey 07094
<http://www.panasonic.com>

Panasonic Sales Company, Division of Matsushita Electric of Puerto Rico, Inc. ("PSC")
Ave. 65 de Infantería, Km. 9.5 San Gabriel Industrial Park, Carolina, Puerto Rico 00985

Panasonic Canada Inc.
5770 Ambler Drive, Mississauga, Ontario L4W 2T3
www.panasonic.ca

