

SPIRIT M SERIES

M-SERIES

USER GUIDE



SAFETY GUIDE

	Page
Safety Symbol Guide	2
Approvals and Notice	3
Warranty	4
Important Safety Instructions	5
Cautions	5
Warnings	6

USER GUIDE

SAFETY SYMBOL GUIDE

For your own safety and to avoid invalidation of the warranty all text marked with these Symbols should be read carefully.



CAUTIONS
Must be followed carefully to avoid bodily injury.



WARNINGS
Must be observed to avoid damage to your equipment.



NOTES
Contain important information and useful tips on the operation of your equipment.

SPIRIT M SERIES

IMPORTANT
Please read this manual carefully before connecting your Mixer to the mains for the first time.

	This equipment complies with the EMC directive 89/336/EEC and LVD 73/23/EEC and 93/68/EEC Environment: E1-E4 This product is approved to safety standards:	
	Product Part Nos: M4: RW5631 M8: RW5632 M12: RW5633	EN60065 : 1994 UK/EU UL6500 : 1996 US CSA E65 : 1994 CAN
Inrush Current: 4 Amps Peak		
For further details contact: Harman International Industries Ltd, Cranborne House, Cranborne Road Potters Bar, Hertfordshire, EN6 3JN, UK		
Tel: +44 (0) 1707 665000 Fax: +44 (0) 1707 660482 e-mail: info@soundcraft.com		

© Harman International Industries Ltd. 2001
All rights reserved

Parts of the design of this product may be protected by worldwide patents.

Part No. ZM0252
Issue: 1.2

Soundcraft is a trading division of Harman International Industries Ltd. Information in this manual is subject to change without notice and does not represent a commitment on the part of the vendor. Soundcraft shall not be liable for any loss or damage whatsoever arising from the use of information or any error contained in this manual.

No part of this manual may be reproduced, stored in a retrieval system, or transmitted, in any form or by any means, electronic, electrical, mechanical, optical, chemical, including photocopying and recording, for any purpose without the express written permission of Soundcraft.

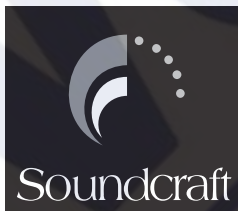

Harman International Industries Limited
 Cranborne House
 Cranborne Road
 POTTERS BAR
 Hertfordshire
 EN6 3JN
 UK

Tel: +44 (0)1707 665000
 Fax: +44 (0)1707 660742
<http://www.soundcraft.com>

USER GUIDE



WARRANTY

- 1 **Soundcraft** is a trading division of Harman International Industries Ltd .
End User means the person who first puts the equipment into regular operation.
Dealer means the person other than Soundcraft (if any) from whom the End User purchased the Equipment, provided such a person is authorised for this purpose by Soundcraft or its accredited Distributor.
Equipment means the equipment supplied with this manual.
- 2 If within the period of twelve months from the date of delivery of the Equipment to the End User it shall prove defective by reason only of faulty materials and/or workmanship to such an extent that the effectiveness and/or usability thereof is materially affected the Equipment or the defective component should be returned to the Dealer or to Soundcraft and subject to the following conditions the Dealer or Soundcraft will repair or replace the defective components. Any components replaced will become the property of Soundcraft.
- 3 Any Equipment or component returned will be at the risk of the End User whilst in transit (both to and from the Dealer or Soundcraft) and postage must be prepaid.
- 4 This warranty shall only be valid if:
 - a) the Equipment has been properly installed in accordance with instructions contained in Soundcraft's manual; and
 - b) the End User has notified Soundcraft or the Dealer within 14 days of the defect appearing; and
 - c) no persons other than authorised representatives of Soundcraft or the Dealer have effected any replacement of parts maintenance adjustments or repairs to the Equipment; and
 - d) the End User has used the Equipment only for such purposes as Soundcraft recommends, with only such operating supplies as meet Soundcraft's specifications and otherwise in all respects in accordance Soundcraft's recommendations.
- 5 Defects arising as a result of the following are not covered by this Warranty: faulty or negligent handling, chemical or electro-chemical or electrical influences, accidental damage, Acts of God, neglect, deficiency in electrical power, air-conditioning or humidity control.
- 6 The benefit of this Warranty may not be assigned by the End User.
- 7 End Users who are consumers should note their rights under this Warranty are in addition to and do not affect any other rights to which they may be entitled against the seller of the Equipment.

SPIRIT M SERIES



IMPORTANT SAFETY INSTRUCTIONS

CAUTIONS

- To avoid the risk of fire, replace the mains fuse only with the correct type and value fuse, as marked on the rear panel.
- **ATTENTION:** - Afin de réduire le risque de feu remplacer seulement avec fusible de même type.
- **MAINS VOLTAGE SELECTION**
This setting is NOT User Adjustable.
This unit is capable of operating at either 230V AC or 115V AC mains voltages $\pm 10\%$, which are set at the time of manufacture and marked on the rear panel. It is important to ensure that the correct mains voltage is present at your mains outlet and that the correct fuse is fitted before switching on the unit.
To change the mains operating voltage, refer to qualified service personnel.
- **REPLACING MAINS FUSE**
Switch the ON/OFF switch to the OFF position. Remove the mains lead from the connector. Use a small screwdriver to unscrew the fuse carrier from its location to the left of the mains power connector. Check the fuse is of the correct type and value and replace if necessary; also check that the voltage selection as marked on the rear panel is correct for the mains supply level before switching the unit ON again.
If the mains fuse fails repeatedly this may be because an electrical safety hazard exists. The unit must be taken out of service and referred to the Soundcraft dealer from where the equipment was purchased.
- **THIS UNIT MUST BE EARTHED**
Under no circumstances should the mains earth be disconnected from the mains lead.
- **ATTENTION:** - Cet appareil doit être branché à la terre.
- The wires in the mains lead are coloured in accordance with the following code:
Replacement Part No: FJ8016 (UK) : FJ8017 (EU) : FJ8018 (US & CAN)

	<u>UK & EU</u>	<u>US & CAN</u>
Earth / Ground:	Green and Yellow	Green and Yellow
Neutral:	Blue	White
Live:	Brown	Black

As the colours of the wires in the mains lead may not correspond with the coloured markings identifying the terminals in your plug, proceed as follows:

The wire which is coloured Green and Yellow must be connected to the terminal in the plug which is marked with the letter E or by the earth / ground symbol: 

The wire which is coloured Blue or White must be connected to the terminal in the plug which is marked with the letter N.

The wire which is coloured Brown or Black must be connected to the terminal in the plug which is marked with the letter L.

Ensure that these colour codings are followed carefully in the event of the plug being changed.

- Do not install near any heat sources such as radiators, heat resistors, stoves, or other apparatus (including amplifiers) that produce heat.

USER GUIDE

- Do not use this apparatus near water.
- Do not defeat the safety purpose of the polarized or grounding type plug. A polarized plug has two blades with one wider than the other. A grounding type plug has two blades and a third grounding prong. The wide blade or the third prong are provided for your safety. When the provided plug does not fit into your outlet, consult an electrician for replacement of the obsolete outlet.
- Protect the power cord from being walked on or pinched particularly at plugs, convenience receptacles and the point where they exit from the apparatus.
- Only use cables and hardware specified by the manufacturer.
- Unplug this apparatus during lightning storms or when unused for long periods of time.
- Refer all servicing to qualified service personnel. Servicing is required when the apparatus has been damaged in any way such as power-supply cord or plug is damaged, liquid has been spilled or objects have fallen into the apparatus, the apparatus has been exposed to rain or moisture, does not operate normally or has been dropped.
- It is recommended that all maintenance and service on the product should be carried out by Soundcraft or its authorised agents. Soundcraft cannot accept any liability whatsoever for any loss or damage caused by service, maintenance or repair by unauthorised personnel.
- If a trolley is used, use caution when moving the trolley / apparatus combination to avoid injury from tip-over.



AVIS: RISQUE DE CHOC ELECTRIQUE
- NE PAS OUVRIR



WARNINGS

- Read these instructions.
- Keep these instructions.
- Heed all warnings.
- Follow all instructions.
- This unit contains no user serviceable parts. Refer all servicing to a qualified service engineer, through the appropriate Soundcraft dealer.
- Clean only with a damp cloth.
- DO NOT block any of the ventilation openings. DO NOT install where air cannot flow over the rear of the unit. DO Install in accordance with the manufacturers instructions.

CONTENTS**SPIRIT M SERIES**

	Page
Overview	8
The 10 Second Tutor	8
Introduction	10
Advice for Those Who Push the Boundaries	10
Installation & Safety Precautions	11
Wiring Up	12
Mono Input Channels	16
Stereo Input Channels	19
Master Section	21
Using Your Spirit M Series Console	23
Advanced Features	25
Application 1 Live Sound Reinforcement	27
Application 2 Multispeaker Applications	28
Application 3 Places of Worship	28
Application 4 Recording	29
Application 5 Linking Two Spirit M Series Consoles	29
Care of Your Mixer	30
Glossary	30
Typical Specifications	32
Dimensions	33
Appendix 1 Typical Connecting Leads	35
System Block Diagram	37
Control Position Markup Sheets	39

USER GUIDE

OVERVIEW

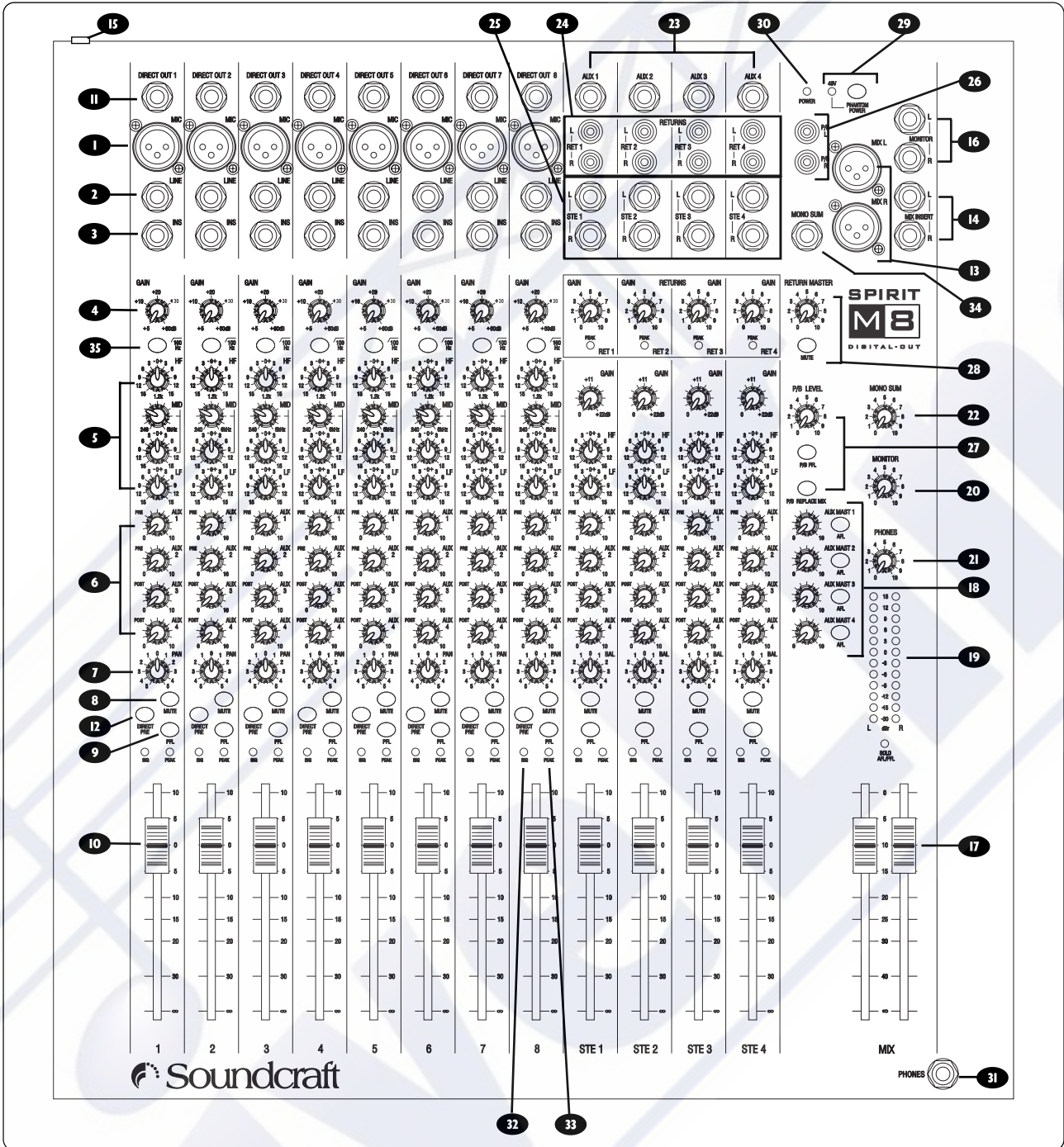

To get you working as fast as possible, this manual begins with a 10 second tutorial. Here you can find quick information on any feature of the console, and a page reference P where you can find a more detailed explanation.

THE 10 SECOND TUTOR



1 MIC INPUT (XLR)

WARNING: Do Not apply Phantom Power before connecting a Microphone.

Connect Microphones here. If you are using a condenser mic ensure phantom power is supplied by pressing the switch at the top of the master section 29 16

2 LINE INPUT (1/4" Jack)

Connect Line level sources here 16

3 INSERT POINT (1/4" Jack)

Connect Signal processors here 16

4 GAIN CONTROL

Adjust this to increase or decrease the level of the incoming signal 17

SPIRIT M SERIES

- 5 EQ STAGE** Adjust these controls to change the signal tone ¹⁷
- 6 AUX SENDS** Adjust these controls to change the level of the signal to an FX unit or an artist's monitors (headphones/in-ear/stage monitors). Aux 1&2 are pre-fade, while Aux 3&4 are post-fade ¹⁷
- 7 PAN CONTROL** Use this control to position the signal within the stereo field ¹⁷
- 8 MUTE SWITCH** When this is pressed you will hear no signal from the channel ¹⁸
- 9 PFL (PRE-FADE LISTEN)** When pressed the signal will appear on the monitor outputs - use this to monitor the post eq signal from the channel ¹⁸
- 10 INPUT CHANNEL FADER** This is used to control the level fed to the Mix Bus ¹⁸
- 11 DIRECT OUTPUT (1/4" Jack)** This output can be used to send the channel signal to a recording device, such as a multi-track recorder ¹⁶
- 12 DIRECT PRE** This switch controls the source for the direct output. When the switch is down the D/O is pre-fade, and when the switch is up the D/O is post-fade ¹⁸
- 13 MIX OUTPUTS (XLR)** Connect these to your analogue recording device, or to your amplification system ²²
- 14 MIX INSERTS (1/4" Jack)** This is a pre-fade break in the signal path which can be used to feed a dynamics or mastering device. The signal is sent from the tip of the jack plug and the return path comes back in on the ring of the jack plug ²²
- 15 S/PDIF OUTPUT** This is a digital version of the Mix Output and can be used to send any source or the entire mix to a digital recorder or computer sequencer via the appropriate hardware ²⁵
- 16 MONITOR O/Ps (1/4" Jack)** These are used to feed your monitoring system. This can be directly to powered monitors, or indirectly via an amplifier to standard monitors ²²
- 17 MASTER FADER** This fader controls the overall level of the mix bus ²²
- 18 AUX MASTERS** These controls can be used to adjust the overall level of a specific auxiliary send to an effects unit ²¹
- 19 MAIN METERS** These show the level of the mix outputs. When the PFL/AFL LED is lit, the meters show the level of the signal sourced ²¹
- 20 MONITOR CONTROL** This controls the level of the signal sent to your monitoring system ²¹
- 21 PHONES CONTROL** This controls the level of the signal sent to the headphones jack socket ²¹
- 22 MONO SUM CONTROL** This controls the level of the signal sent to the mono sum output ²²
- 23 AUX OUTPUTS (1/4" Jack)** These four outputs can be used to send the channel signal to an FX unit or an artist's monitors (headphones/in-ear/stage monitors). Aux 1&2 are pre-fade, Aux 3&4 are post-fade ²⁰
- 24 STEREO RETURN INPUTS (RCA Phono)** These four inputs can be used to connect the return signal from an FX unit, or a stereo feed from consumer devices such as CD-Players, Minidisc etc. The level of these inputs are controlled by the RET1,2,3 & 4 controls and are sub-mixed via the returns master control before being sent to the Mix Outputs ¹⁹
- 25 STEREO INPUTS (1/4" Jack)** These four inputs can be used to connect line level stereo inputs from keyboards, sound modules, samplers, computer based audio cards etc. These inputs pass through a normal channel strip, with EQ, Auxes and a Balance control ¹⁹
- 26 PLAYBACK INPUT (RCA Phono)** Here you can connect the playback from your recording device ²²
- 27 PLAYBACK CONTROLS** Use this to control the level of the playback signal. There is also a PFL/AFL switch and a PLAYBACK REPLACES MIX switch ²¹
- 28 RETURNS MASTER** This controls the overall level of the stereo return inputs. There is also a MUTE switch so that you can quickly compare your mix, with and without FX ²²
- 29 PHANTOM POWER** Press this to switch the phantom power (48V) on for condenser microphones **WARNING:** Do Not apply Phantom Power before connecting a microphone ²¹
- 30 MIXER POWER LED** This LED will light when the unit is switched on ²¹
- 31 HEADPHONES (1/4" Jack)** Plug your headphones into this socket ²⁷
- 32 SIGNAL PRESENT LED** This is used to indicate the presence of a signal on a specific channel ¹⁸
- 33 PEAK LED** This is used to indicate signal clipping on a specific channel ¹⁸
- 34 MONO SUM OUTPUT** This output provides a Mono sum of the main L & R mix outputs ²²
- 35 100Hz FILTER** When pressed, this switch significantly reduces the level of frequencies below 100Hz ¹⁷



USER GUIDE

INTRODUCTION

Thank you for purchasing a Soundcraft mixer. We take great pride in our latest addition to the Spirit range of mixing consoles - you have taken a step in the right direction and should never look back.

The Packaging which your Spirit M Series arrived in, forms part of the product and must be retained for future use.

Owning a Soundcraft console brings you the expertise and support of one of the industry's leading manufacturers, and the results of nearly 3 decades of supporting some of the biggest names in the business. Our knowledge has been attained through working in close contact with leading professionals and institutes to bring you products designed to get the best possible results from your mixing.

Built to the highest standards using quality components and surface mount technology, the Spirit M Series is designed to be as easy to use as possible. We have spent years researching the most efficient methods of control for two key reasons:

- 1) Engineers, musicians, writers and programmers all need to have very few interruptions to the creative process; our products have been designed to be almost transparent, allowing this process to breathe.
- 2) Whether performing or recording, time is a very expensive and rare commodity. Our products have a user interface which is recognised by millions to be the industry standard because of its efficiency.

The sonic qualities of our products are exemplary - some of the same circuits which are used on our most expensive consoles are employed in the Spirit M Series, bringing you the great Soundcraft quality in a small format console without compromise.

You will also be glad to know you have a one year warranty with your product from the date of purchase. The Spirit M Series has been designed using the latest high-end software based engineering packages. Every console from Soundcraft has been proven to stand up to all the stress and rigours of modern day mixing environments.

The entire Spirit M Series is manufactured using some of the most advanced techniques in the world, from high density surface mount PCB technology, to computer aided test equipment able to measure signals well outside the range of normal hearing. As each console passes through to be quality checked before packing there is also a human listening station. Something we have learnt over the years is that the human touch counts - and only by using people can you ensure the product meets the high demands of the user.



ADVICE FOR THOSE WHO PUSH THE BOUNDARIES

Although your new console will not make any noise until you feed it signals, it has the capability to produce sounds which when monitored through an amplifier or headphones can damage hearing over time.

Please take care when working with your audio - if you are manipulating controls which you don't understand (which we all do when we need to learn), make sure your monitors are turned down. Remember that your ears are the most important tool of your trade, look after them, and they will look after you.

Most importantly - don't be afraid to experiment to find out how each parameter affects the sound - this will extend your creativity and help you to get the best from your mixer and the most respect from your artists and audience.

SPIRIT M SERIES**INSTALLATION AND SAFETY PRECAUTIONS****ABOUT THIS MANUAL**

This manual describes the safety precautions, warnings, specifications, installation and operating procedures specific to the following Soundcraft products only:

- **Spirit M4** **RW5631 UK / EU / US**
- **Spirit M8** **RW5632 UK / EU / US**
- **Spirit M12** **RW5633 UK / EU / US**

The information in this manual should be read by end users of one of the above products only. In particular, this manual should not be read in conjunction with any other product not listed above.

The above products do not contain any user-serviceable parts and the user guide does not contain any technical servicing information. Qualified service personnel can obtain a separate Technical Manual incorporating the user guide, Part No ZM0255 from Soundcraft or one of its accredited distributors.

Information in this manual is subject to change without notice and does not represent a commitment on the part of the vendor. Soundcraft shall not be liable for any loss or damage whatsoever arising from the use of information or any error contained in this manual.

INSTALLING THE MIXER

Correct connection and positioning of your mixer is important for successful and trouble-free operation. The following sections are intended to give guidance with cabling, connections and configuration of your mixer.

- Choose the mains supply for the sound system with care, and do not share sockets or earthing with lighting dimmers.
- Position the mixer where the sound can be heard clearly.
- Run audio cables separately from dimmer wiring, using balanced lines wherever possible. If necessary, cross audio and lighting cables at right angles to minimise the possibility of interference. Keep unbalanced cabling as short as possible.
- Check your cables regularly and label each end for easy identification.

SAFETY PRECAUTIONS

For your own safety and to avoid invalidation of the warranty please read this section carefully.

In particular, you should also read the Cautions and Warnings on pages 5-6 of this manual.



The console must only be connected to the Mains Power voltage indicated on the rear panel.

To avoid the risk of fire, replace the mains fuse only with the correct value fuse, as indicated on the rear panel.

USER GUIDE

INPUTS

Balanced Mic XLR

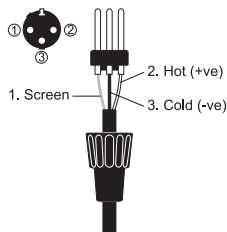

Unbalanced Mic XLR

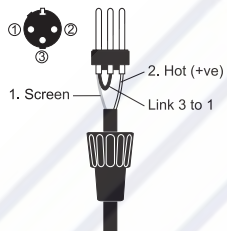

3 pole jack 2 pole jack Balanced Unbalanced

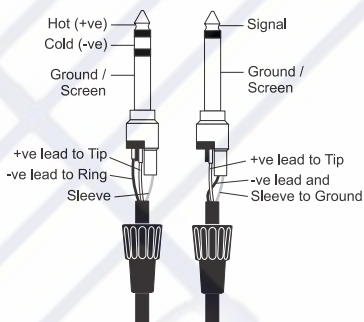

Inserts

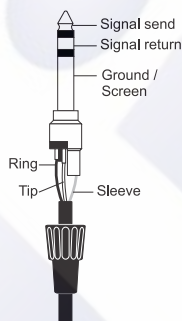

WIRING UP

Please refer to pages 35/36 for additional wiring details.

MIC INPUT

The mic input accepts XLR-type connectors and is designed to suit a wide range of BALANCED or UNBALANCED low-level signals, whether from delicate vocals requiring the best low-noise performance or close-miked drum kits needing maximum headroom. Professional dynamic, condenser or ribbon mics are best because these will be LOW IMPEDANCE. While you can use low-cost HIGH IMPEDANCE mics, you do not get the same degree of immunity to interference on the microphone cable and as a result the level of background noise may be higher. If you turn the PHANTOM POWER on, the socket provides a suitable powering voltage for professional condenser mics.

DO NOT use UNBALANCED sources with the phantom power switched on. The voltage on pins 2 & 3 of the XLR connector may cause serious damage. BALANCED dynamic mics may normally be used with phantom power switched on (contact your microphone manufacturer for guidance)

The input level is set using the input GAIN knob.

The LINE input offers the same gain range as the MIC input, but at a higher input impedance, and is 20dB less sensitive. This is suitable for most line level sources

WARNING !
Start with the input GAIN knob turned fully anticlockwise when plugging high level sources into the LINE input to avoid overloading the input channel or giving you a very loud surprise!

LINE INPUT

Accepts 3-pole 'A' gauge jacks, or 2-pole mono jacks which will automatically ground the 'cold' input. Use this input for sources other than mics, such as keyboards, drum machines, synths, tape machines or guitars. The input is BALANCED for low noise and immunity from interference, but you can use UNBALANCED sources by wiring up the jacks as shown, although you should then keep cable lengths as short as possible to minimise interference pick-up on the cable. Note that the ring must be grounded if the source is unbalanced. Set the input level using the GAIN knob, starting with the knob turned fully anticlockwise. Unplug any MIC connection when using the LINE input.

INSERT POINT

The unbalanced, pre-EQ insert point is a break in the channel signal path, allowing limiters, compressors, special EQ or other signal processing units to be added in the signal path. The Insert is a 3-pole 'A' gauge jack socket which is normally bypassed. When a jack is inserted, the signal path is broken, just before the EQ section.

The signal from the channel appears on the TIP of the plug and is returned on the RING, with the sleeve as a common ground.

The Send may be tapped off as an alternative pre-fade, pre-EQ direct output if required, using a lead with tip and ring shorted together so that the signal path is not interrupted.

SPIRIT M SERIES

OUTPUTS

Mix Output
Aux Outputs
Mono Output
Monitor Outputs
Direct Outputs

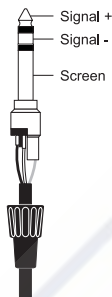

Mix Inserts

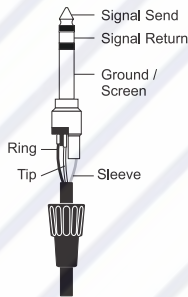

Headphones



STEREO RETURNS RET-1/2/3/4

These accept RCA phono jacks to allow easy connection to hi-fi equipment or DAT players. The input is unbalanced, and ideal for pre-show music sources or signals that do not require any EQ or effects. These can also be used as effect returns using cables described later in this document.

STEREO INPUTS STE-1/2/3/4

These accept 3-pole 'A' gauge jacks, or 2-pole mono jacks which will automatically ground the 'cold' input. Use these inputs for sources such as keyboards, drum machines, synths, tape machines or as returns from processing units. The input is BALANCED for low noise and immunity from interference, but you can use UNBALANCED sources by wiring up the jacks as shown, although you should then keep cable lengths as short as possible to minimise interference pick-up on the cable. Note that the ring must be grounded if the source is unbalanced.

Mono sources can be fed to both paths by plugging into the Left jack only.

MIX INSERTS

The unbalanced, pre-fade Mix insert point is a break in the output signal path to allow the connection of, for example, a compressor/limiter or graphic equaliser. The Insert is a 3-pole 'A' gauge jack socket which is normally bypassed. When a jack is inserted, the signal path is broken, just before the mix fader.

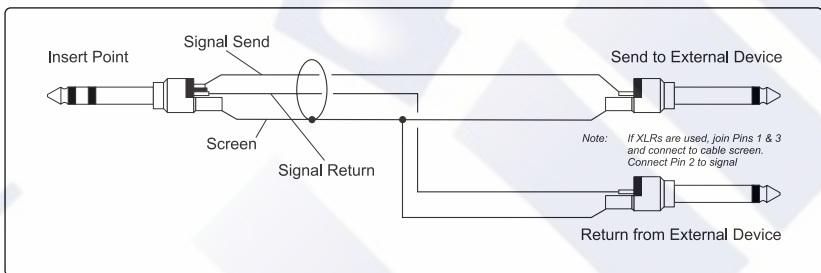

The mix signal appears on the TIP of the plug and is returned on the RING. A 'Y' lead may be required to connect to equipment with separate send and return jacks as shown below:

MIX & SUB OUTPUTS

The MIX and SUB outputs are on 3-pole 'A' gauge jack sockets, wired as shown, and incorporate impedance balancing, allowing long cable runs to balanced amplifiers and other equipment.

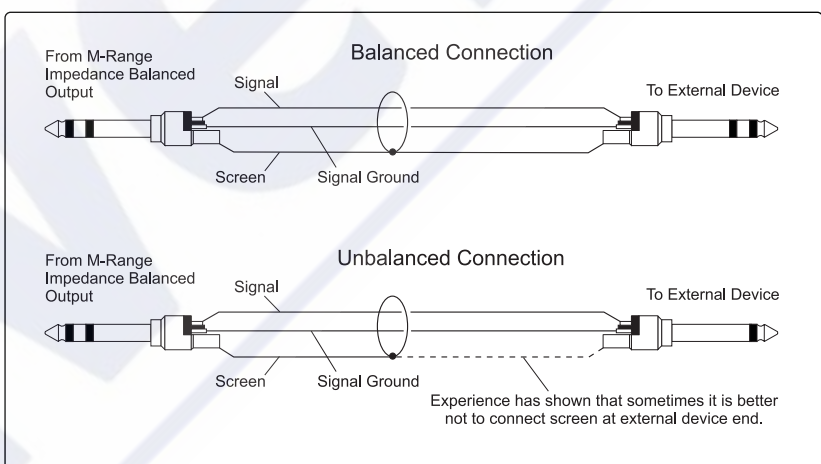

USER GUIDE

OUTPUTS

Mix Output
Aux Outputs
Mono Output
Monitor Outputs
Direct Outputs

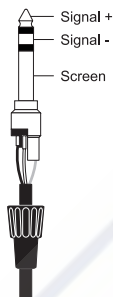

Mix Inserts

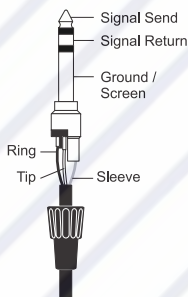

Headphones



AUX OUTPUTS

The Aux outputs are on 3-pole 'A' gauge jack sockets, wired as shown on the left, and are balanced, allowing long cable runs to balanced amplifiers and other equipment.

CHANNEL DIRECT OUTPUTS

The Direct outputs are on 3-pole 'A' gauge jack sockets, wired as shown on the left, and are unbalanced.

HEADPHONES

The PHONES output is a 3-pole 'A' gauge jack, wired as a stereo output as shown, suitable for headphones of 200Ω or greater. 8Ω headphones are not recommended.

POLARITY (PHASE)

You will probably be familiar with the concept of polarity in electrical signals and this is of particular importance to balanced audio signals. Just as a balanced signal is highly effective at cancelling out unwanted interference, so two microphones picking up the same signal can cancel out, or cause serious degradation of the signal if one of the cables has the +ve and -ve wires reversed. This phase reversal can be a real problem when microphones are close together and you should therefore take care always to connect pins correctly when wiring audio cables.

GROUNDING AND SHIELDING

For optimum performance use balanced connections where possible and ensure that all signals are referenced to a solid, noise-free earthing point and that all signal cables have their screens connected to ground. In some unusual circumstances, to avoid earth 'loops' ensure that all cable screens and other signal earths are connected to ground only at their source and not at both ends.

If the use of unbalanced connections is unavoidable, you can minimise noise by following these wiring guidelines:

- On INPUTS, unbalance at the source and use a twin, screened cable as though it were balanced.
- On OUTPUTS, connect the signal to the +ve output pin, and the ground of the output device to -ve. If a twin screened cable is used, connect the screen only at the mixer end.
- Avoid running audio cables or placing audio equipment, close to thyristor dimmer units or power cables.
- Noise immunity is improved significantly by the use of low impedance sources, such as good quality professional microphones or the outputs from most modern audio equipment. Avoid cheaper high impedance microphones, which may suffer from interference over long cable runs, even with well-made cables.

Grounding and shielding is still seen as a black art, and the suggestions above are only guidelines. If your system still hums, an earth loop is the most likely cause. Two examples of how an earth loop can occur are shown below.

Example 1

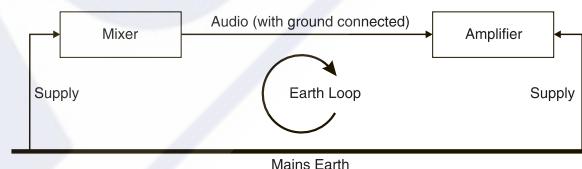

Example 2

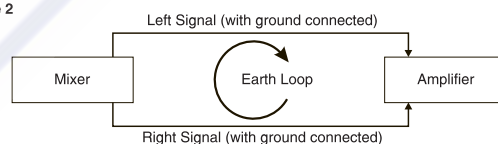

WARNING! Under NO circumstances must the mains earth be disconnected from the mains lead.

SPIRIT M SERIES

PROBLEM SOLVING

Basic problem solving is within the scope of any user if a few basic rules are followed.

- Get to know the Block Diagram of your console (see page 36).
- Get to know what all parameters and/or connection in the system are supposed to do.
- Learn where to look for common trouble spots.

The Block Diagram is a representative sketch of all the components of the console, showing how they connect together and how the signal flows through the system. Once you have become familiar with the various component blocks you will find the Block Diagram is quite easy to follow and you will have gained a valuable understanding of the internal structure of the console.

Each Component has a specific function and only by getting to know what each part is supposed to do will you be able to tell if there is a genuine fault! Many 'faults' are the result of incorrect connection or control settings which may have been overlooked.

Basic Troubleshooting is a process of applying logical thought to the signal path through the console and tracking down the problem by elimination.

- Swap input connections to check that the source is really present. Check both Mic and Line inputs.
- Eliminate sections of the channel by using the insert point to re-route the signal to other inputs that are known to be working.
- Route channels to different outputs or to auxiliary sends to identify problems on the Master section.
- Compare a suspect channel with an adjacent channel which has been set up identically. Use PFL and AFL to monitor the signal in each section.
- Insert contact problems may be checked by using a dummy jack with tip and ring shorted together as shown below. If the signal appears when the jack is inserted it shows that there is a problem with the normalising contacts on the jack socket, caused by wear or damage, or often just dirt or dust. Keep a few in your gig tool box.

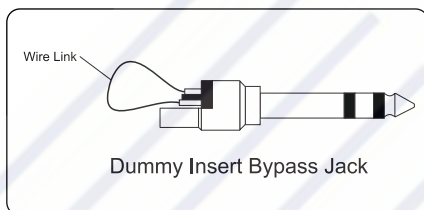

If in doubt please contact Soundcraft customer support.

PRODUCTS UNDER WARRANTY

USA customers should contact **Alex Welti (e-mail: awelti@harman.com)** National Service Manager at Soundcraft USA. Telephone: (615) 360-0458

UK customers should contact their local Dealer.

Outside the UK and USA, customers are requested to contact their territorial distributor who is able to offer support in the local time zone and language. Please see the Distributor listings on our website (<http://www.soundcraft.com>) to locate your Local Distributor.

OUT-OF-WARRANTY PRODUCTS

For out-of-warranty consoles purchased in the United Kingdom, please contact the **Customer Services Department (e-mail: csd@soundcraft.com)** at the factory in Potters Bar, Hertfordshire: Telephone +44 (0)1707 665000.

For all other out-of-warranty consoles, please contact the appropriate territorial distributor.

When mailing or faxing please remember to give as much information as possible. This should include your name, address and a daytime telephone number.

Should you experience any difficulty please contact **Customer Services Department (e-mail: csd@soundcraft.com)**

USER GUIDE

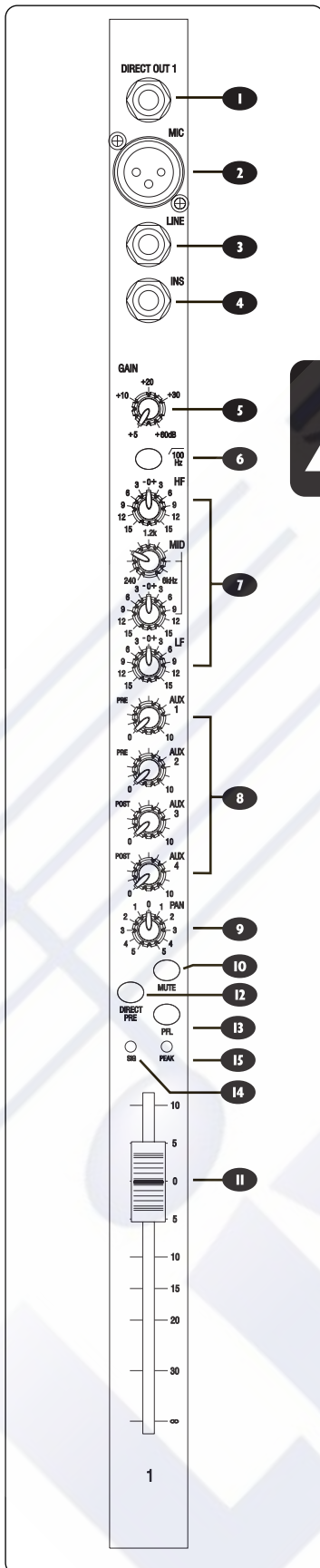

MONO INPUT CHANNEL

1 DIRECT OUTPUT

The first eight channels have a dedicated Direct Output which allows direct connection to external devices, for example to feed Tape Machines or effects units.

2 MIC INPUT

The mic input accepts XLR-type connectors and is designed to suit a wide range of BALANCED or UNBALANCED signals. Professional dynamic, condenser or ribbon mics are best because these will be LOW IMPEDANCE. You can use low-cost HIGH IMPEDANCE mics, but the level of background noise will be higher. If you turn the PHANTOM POWER on (top right-hand side of the mixer) the socket provides a suitable powering voltage for professional condenser mics.

ONLY connect condenser microphones with the +48V powering OFF, and ONLY turn the +48V powering on or off with all output faders DOWN, to prevent damage to the mixer or external devices.

TAKE CARE when using unbalanced sources, which may be damaged by the phantom power voltage on pins 2 & 3 of the XLR connector.

Unplug any mics if you want to use the LINE Input. The input level is set using the GAIN knob.

3 LINE INPUT

Accepts 3-pole 'A' gauge (TRS) jacks. Use this input for sources other than mics, such as keyboards, drum machines, synths, tape machines or guitars. The input is BALANCED for low noise and top quality from professional equipment, but you can use UNBALANCED sources by wiring up the jacks as shown below, although you should then keep cable lengths as short as possible. Unplug anything in the MIC input if you want to use this socket. Set the input level using the GAIN knob.

4 INSERT POINT (ALTERNATIVE DIRECT SEND)

The unbalanced, pre-EQ insert point is a break in the channel signal path, allowing limiters, compressors, special EQ or other signal processing units to be added in the signal path. The Insert is a 3-pole 'A' gauge jack socket which is normally bypassed. When a jack is inserted, the signal path is broken, just before the EQ section.

The Send may be tapped off as an alternative pre-fade, pre-EQ direct output if required, using a lead with tip and ring shorted together so that the signal path is not interrupted (see below).

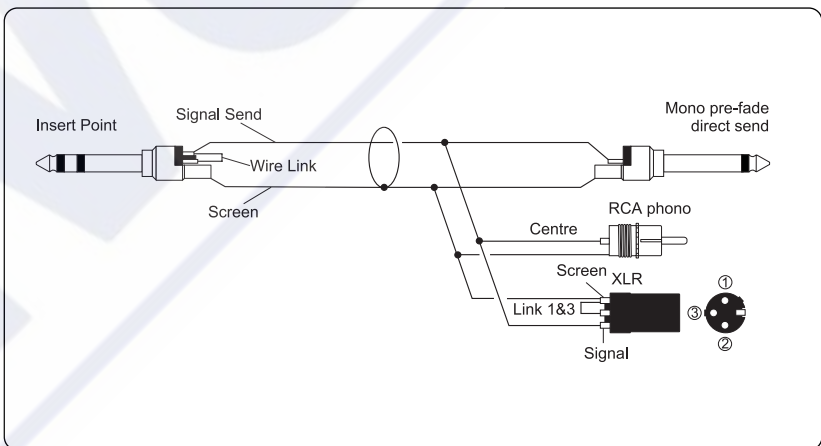

SPIRIT M SERIES

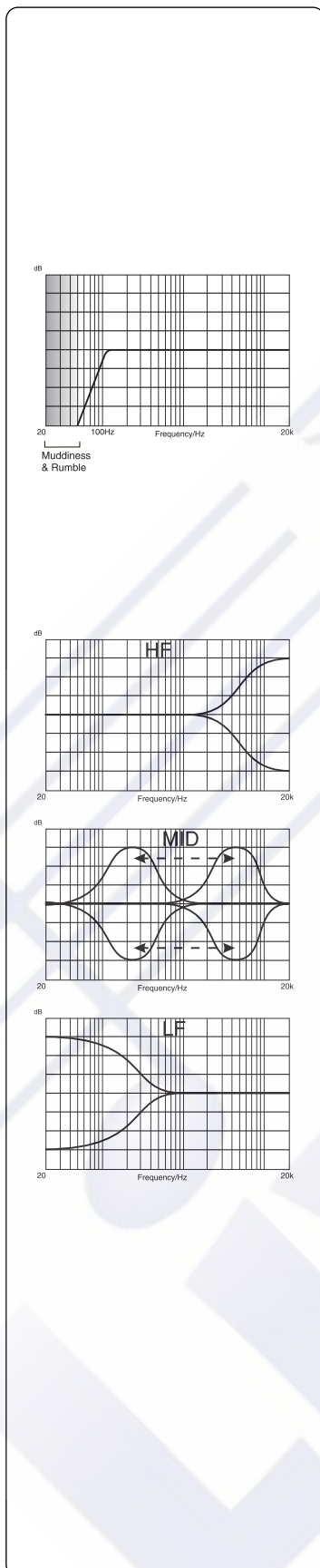

5 GAIN

This knob sets how much of the source signal is sent to the rest of the mixer. Too high, and the signal will distort as it overloads the channel. Too low, and the level of any background hiss will be more noticeable and you may not be able to get enough signal level to the output of the mixer.

Note that some sound equipment, particularly that intended for domestic use, operates at a lower level (-10dBV) than professional equipment and will therefore need a higher gain setting to give the same output level.

See 'Initial Set Up' on page 23 to learn how to set GAIN correctly.

6 100Hz HI-PASS FILTER

Pressing this switch activates a steep 18dB per octave filter which reduces the level of bass frequencies only, and is a real bonus for a such a small mixer. Use this in live PA situations to clean up the mix, reducing stage rumble or 'popping' from microphones.

7 EQUALISER

The Equaliser (EQ) allows fine manipulation of the sound, particularly to improve the sound in live PA applications where the original signal is often far from ideal and where slight boosting or cutting of particular voice frequencies can really make a difference to clarity. There are three sections giving the sort of control usually only found on much larger mixers. The EQ knobs can have a dramatic effect, so use them sparingly and listen carefully as you change any settings so that you get to know how they affect the sound.

HF EQ

Turn to the right to boost high (treble) frequencies above 12kHz by up to 15dB, adding crispness to cymbals, vocals and electronic instruments. Turn to the left to cut by up to 15dB, reducing hiss or excessive sibilance which can occur with certain types of microphone. Set the knob in the centre-detented position when not required.

MID EQ

There are two knobs which work together to form a SWEPT MID EQ. The lower knob provides 15dB of boost and cut, just like the HF EQ knob, but the frequency at which this occurs can be set by the upper knob over a range of 240Hz to 6kHz. This allows some truly creative improvement of the signal in live situations, because this mid band covers the range of most vocals. Listen carefully as you use these controls together to find how particular characteristics of a vocal signal can be enhanced or reduced. Set the lower knob to the centre-detented position when not required.

LF EQ

Turn to the right to boost low (bass) frequencies below 60Hz by up to 15dB, adding warmth to vocals or extra punch to synths, guitars and drums. Turn to the left to cut low frequencies by up to 15dB for reducing hum, stage rumble or to improve a mushy sound. Set the knob to the centre-detented position when not required.

8 AUX SENDS

These are used to set up separate mixes for FOLDBACK, EFFECTS or recording, and the combination of each the Aux Send is mixed to the respective Aux Output at the rear of the mixer. For Effects it is useful for the signal to fade up and down with the fader (this is called POST-FADE), but for Foldback or Monitor feeds it is important for the send to be independent of the fader (this is called PRE-FADE).

AUX SENDS 1 AND 2

These are always PRE-FADE and therefore most appropriate for foldback or monitor mixes or external submix.

AUX SENDS 3 AND 4

These are always POST-FADE for effects sends, external submix (or for Centre Voice cluster or mono Tape mix).

9 PAN

This control sets the amount of the channel signal feeding the Left and Right MIX or SUB buses, allowing you to move the source smoothly across the stereo image. When the control is turned fully left or right you are able to route the signal at unity gain to either left or right outputs individually.

USER GUIDE

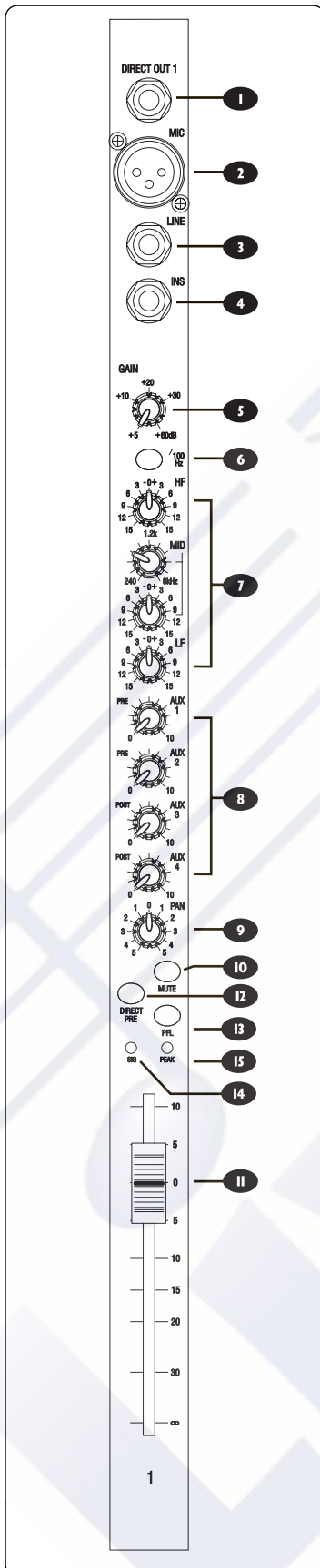

10 MUTE

All outputs from the channel except inserts are on when the MUTE switch is released and muted when the switch is down, allowing levels to be pre-set before the signal is required. The only exception to the muting is any DIRECT OUTPUT configured as PRE-fade, which will be sent regardless of the status of the mute switch.

11 INPUT CHANNEL FADER

The 100mm FADER, with a custom-designed law to give even smoother control of the overall signal level in the channel strip, allows precise balancing of the various source signals being mixed to the Master Section. You get most control when the input GAIN is set up correctly, giving full travel on the fader. See the 'Initial Set Up' section on page 23 for help in setting a suitable signal level.

12 DIRECT PRE/POST

This button switches the Direct Output to be set pre or post the channel fader. In the UP position it is POST and in the DOWN position it is PRE.

13 PFL (Pre-Fade Listen)

When the latching PFL switch is pressed, the pre-fade signal is fed to the headphones, control room output and meters, where it replaces the MIX. The PFL/AFL LED on the Master section illuminates to warn that a PFL is active. This is a useful way of listening to any required input signal without interrupting the main mix, for making adjustments or tracing problems. When PFL is pressed anywhere on the console, the Control Room outputs automatically switch from monitoring the Mix Outputs.

14 SIGNAL PRESENT LED

This LED will light when the channel signal exceeds -20dBu.

15 PEAK LED

This LED will light when the signal peaks (+18dBu internal). There is a three point signal analysis, and if the signal peaks at any of these points then the LED will light:

- a) PRE-EQ
- b) POST-EQ
- c) POST-FADE

SPIRIT M SERIES

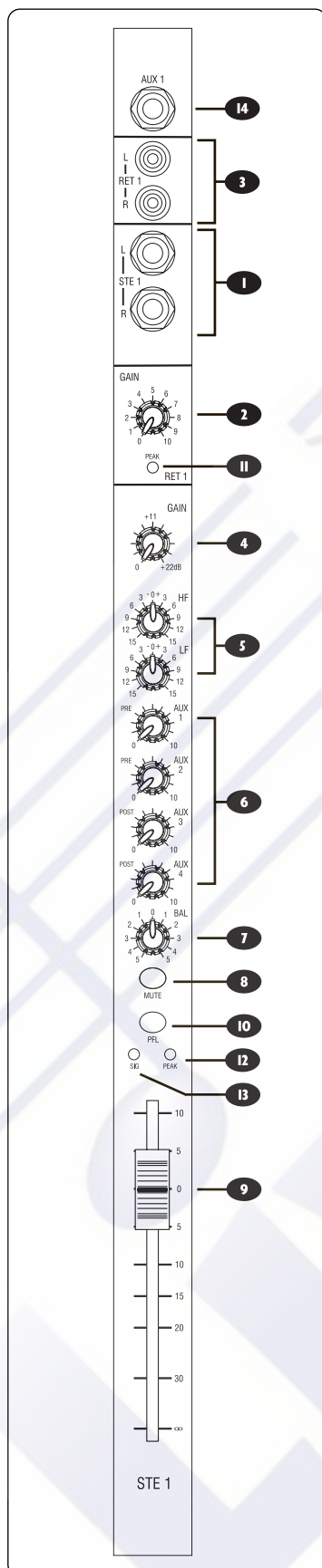

STEREO INPUT CHANNELS

Each stereo input channel comprises two pairs of inputs per channel strip:

1 INPUTS STE-1/2/3/4

These inputs accept 3-pole 'A' gauge (TRS) jacks. Use these inputs for sources such as keyboards, drum machines, synths, tape machines or processing units. The inputs are **BALANCED** for low noise and top quality from professional equipment, but you can use **UNBALANCED** sources by wiring up the jacks as shown in the "Wiring it Up" section earlier in this manual, although you should then keep cable lengths as short as possible. Mono sources may be used by plugging into the left jack only.

2 GAIN

The GAIN control sets the level of the channel signal.

3 RETURNS RET-1/2/3/4

These inputs are unbalanced on RCA phono connectors, and are intended for use with CD players, DAT machines or Hi-Fi equipment. Alternatively they may be used as simple effects returns or stereo instrument inputs.

4 GAIN

The GAIN control sets the input level to the channel, allowing matching to a wide range of line level sources.

5 EQUALISER

HF EQ

Turn to the right to boost high (treble) frequencies, adding crispness to percussion from drum machines, synths and electronic instruments. Turn to the left to cut these frequencies, reducing hiss or excessive brilliance. Set the knob in the centre-detented position when not required. The control has a shelving response giving 15dB of boost or cut at 12kHz.

LF EQ

Turn to the right to boost low (bass) frequencies, adding extra punch to synths, guitars and drums. Turn to the left to reduce hum, boominess or improve a mushy sound. Set the knob to the centre-detented position when not required. The control has a shelving response giving 15dB of boost or cut at 60Hz.

6 AUX SENDS

These are used to set up a separate mixes for FOLDBACK, EFFECTS or recording, and the combination of each the Aux Send is mixed to the respective Aux Output at the rear of the mixer. For Effects it is useful for the signal to fade up and down with the fader (this is called POST-FADE), but for Foldback or Monitor feeds it is important for the send to be independent of the fader (this is called PRE-FADE).

AUX SENDS 1 AND 2

These are always PRE-FADE and therefore most appropriate for foldback or monitor mixes or external submix.

AUX SEND 3 AND 4

These are always POST-FADE for effects sends, external submix (or for centre Voice cluster or mono Tape mix).

7 BALANCE

This control sets the amount of the channel signal feeding the Left and Right MIX or SUB buses, allowing you to balance the source in the stereo image. When the control is turned fully right or left you feed only that side of the signal to the mix. Unity gain is provided by the control in the centre-detented position.

8 MUTE

All outputs from the channel are enabled when the MUTE switch is released and muted when the switch is down.

USER GUIDE

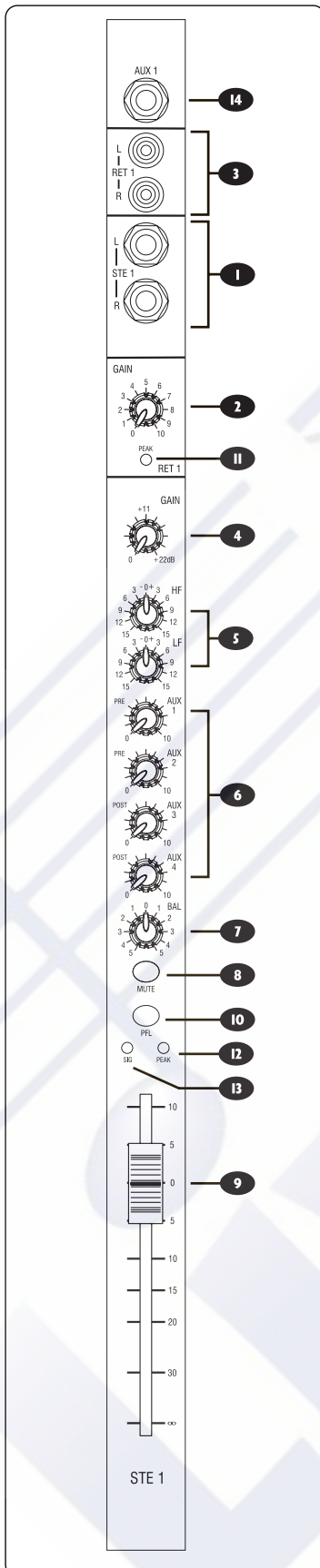

9 FADER

The 100mm FADER gives you smooth control of the overall signal level in the channel strip, allowing precise balancing of the various source signals being mixed to the Master Section. It is important that the input level is set correctly to give maximum travel on the fader which should normally be used at around the '0' mark. See the 'Initial Set Up' section on page 23 for help in setting the right level.

10 PFL

When the latching PFL switch is pressed, the pre-fade signal is fed in mono to the headphones, control room output and meters, where it replaces the MIX. The PFL/AFL LED on the Master section illuminates to warn that a PFL is active. The Left and Right meters display the PFL signal in mono. This is a useful way of listening to any required input signal without interrupting the main mix, for making adjustments or tracing problems.

11 RETURN PEAK LED

This LED will light when the return input signal peaks (+18dBu internal).

12 CHANNEL PEAK LED

This LED will light when the signal peaks (+18dBu internal). There is a three point signal analysis, and if the signal peaks at any of these points then the LED will light:

- PRE-EQ
- POST-EQ
- POST-FADE

13 SIGNAL PRESENT LED

This LED will light when the channel signal exceeds -20dBu.

14 AUX OUTPUTS (1-4)

These outputs are on 3-pole 'A' gauge jacks and are balanced outputs

SPIRIT M SERIES

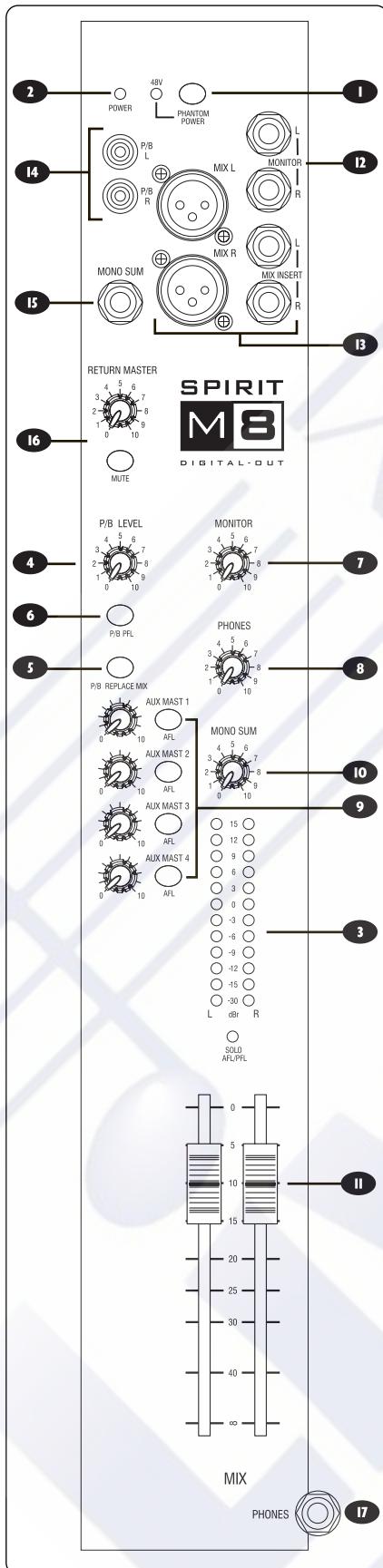

MASTER SECTION

1 PHANTOM POWER

Many professional condenser mics need PHANTOM POWER, which is a method of sending a powering voltage down the same wires as the mic signal. Press the switch to enable the +48V power to all of the MIC inputs. The adjacent LED illuminates when the power is active.



WARNING: TAKE CARE when using unbalanced mics which may be damaged by the phantom power voltage. Balanced dynamic mics can normally be used with phantom power switched on (contact your microphone manufacturer for guidance)

Mics should always be plugged in, and all output faders set to minimum before switching the Phantom Power ON to avoid damage to external equipment

2 POWER INDICATOR

This LED lights to show when power is connected to the console.

3 BARGRAPH METERS

The three-colour peak reading BARGRAPH METERS normally show the level of the MIX RIGHT and MIX LEFT outputs, giving you a constant warning of excessive peaks in the signal which might cause overloading. Aim to keep the signal just touching the red segments at peak levels for best performance.

Similarly, if the output level is too low and hardly registering at all on the meters, the level of background noise may become significant. Take care to set up the input levels for best performance.

When any PFL switch is pressed, the meters switch to show the selected PFL signal on both meters, in mono.

4 PLAYBACK

The rotary control sets the level of the 2 Track Tape input, which is routed to the headphones, monitor outputs and meters. These inputs, on RCA phono connectors are an ideal way to connect the playback of a tape machine for monitoring.

5 PLAYBACK REPLACES MIX

Press this switch to replace the MIX Left/Right signal at the MIX outputs with the Playback signal connected to the Left and Right RCA sockets (14) (see also p.22).

6 PLAYBACK PFL

Press this switch to route the Playback signal to the monitor and phones, over-riding the default monitor/Phones signal. This listening point is **before** the PB LEVEL control, so material can be previewed before being routed.

7 MONITOR LEVEL

This control sets the level to the MONITOR LEFT & RIGHT outputs. If headphones are plugged into the PHONES jack, the headphone level will track the Monitor Level.

8 PHONES LEVEL

This control sets the output level to the Headphone outputs. If headphones are plugged into the PHNS jack, then the knob sets a comfortable headphone listening level without affecting the Monitor output levels.

9 AUX MASTERS

Each Aux output has a master output level control and associated AFL switch.

AUX AFLs

Just like the PFL switches on the channels, you can monitor each AUX output by pressing the AFL switch. This routes the AUX output signal to the MONITOR or PHONES, replacing the MIX signal. The METERS also switch from the MIX to display the PFL/AFL signal and the PFL/AFL LED lights to warn that a PFL or AFL switch is pressed. When you release the switch, the Monitor swaps back to the MIX.

USER GUIDE

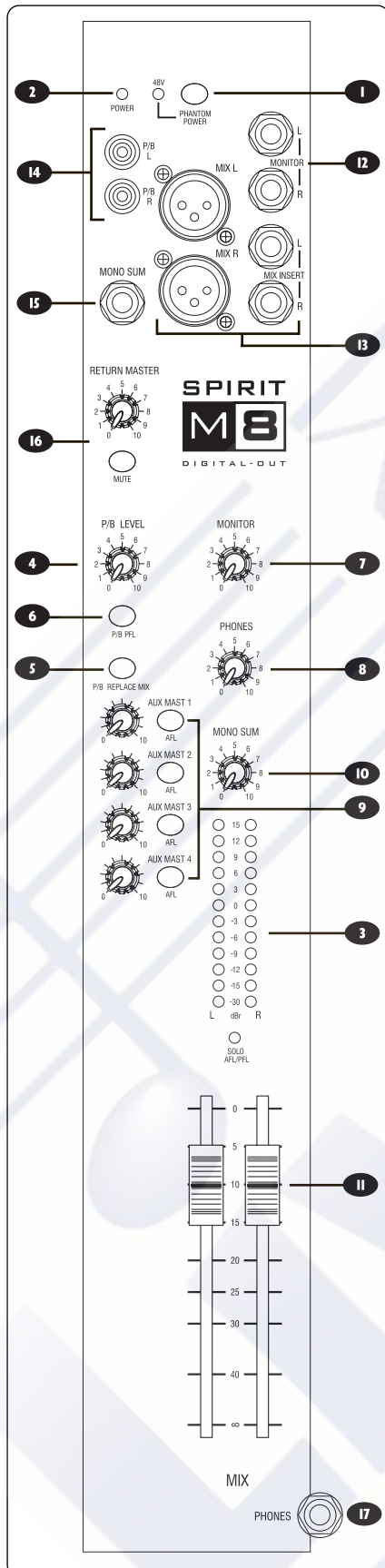

10 MONO SUM

The Mix Left and Right signals are summed to a MONO output on a 3 pole 'A' gauge jack (15). Output level is set by the dedicated rotary control. Monitoring of the Mono output, if required, must be done at the external equipment it feeds, or the signal brought back to a spare console input.

11 MASTER FADERS

The MASTER FADERS set the final level of the MIX outputs, and separate faders are provided for each output. These should normally be set close to the '0' mark if the input GAIN settings have been correctly set, to give maximum travel on the faders for smoothest control.

12 MONITOR OUTPUTS

The Monitor Outputs are on 3-pole 'A' gauge jacks and are balanced connections

13 MIX OUTPUTS & INSERTS

The Mix LEFT and RIGHT outputs are sent from the XLR sockets as balanced signals. The Mix INSERT points are on 3-pole 'A' gauge jacks and are unbalanced.

14 PLAYBACK INPUTS

These two RCA phono sockets are unbalanced Left and Right line-level inputs, used for connecting the playback devices selected using button (5) (see also p.21) e.g. DAT or CD players, Minidisc, Cassette tape recorders etc.

15 MONO SUM OUTPUT

The MONO Sum output is on a 3-pole 'A' gauge jack output and is balanced.

16 RETURN MASTER / MUTE

This rotary control adjusts the overall level of the four stereo return inputs to the Mix. There is also a mute switch which can be used to quickly compare the level of the Mix, with and without effects.

17 HEADPHONES JACK

This output is on a 3-pole 'A' gauge stereo jack socket and accepts headphones of approximately 200Ω impedance.

SPIRIT M SERIES

USING YOUR SPIRIT M SERIES CONSOLE

The final sound from your PA system can only ever be as good as the weakest link in the chain, and especially important is the quality of the source signal because this is the starting point of the chain. Just as you need to become familiar with the control functions of your mixer, so you must recognise the importance of correct choice of inputs, microphone placement and input channel settings. However, no amount of careful setting up can take account of the spontaneity and unpredictability of live performance. The mixer must be set up to provide 'spare' control range to compensate for changing microphone position and the absorption effect of a large audience (different acoustic characteristics from sound check to show).

MICROPHONE PLACEMENT

Careful microphone placement and the choice of a suitable type of microphone for the job is one of the essentials of successful sound reinforcement. The diagrams on the left show the different pick-up patterns for the most common types of microphone. Cardioid microphones are most sensitive to sound coming from in front, and hypercardioid microphones offer even greater directivity, with a small amount of pickup behind the microphone. These types are ideal for recording vocalists or instruments, where rejection of unwanted sounds and elimination of feedback is important. The aim should be to place the microphone as close as physically possible to the source, to cut out unwanted surrounding sounds, allow a lower gain setting on the mixer and avoid feedback. Also a well-chosen and well-placed microphone should not need any appreciable equalisation.

There are no exact rules - let your ears be the judge. In the end, the position that gives the desired effect is the correct position!

INITIAL SET UP

Once you have connected up your system (see the sections on connection and wiring earlier in this manual for guidance) you are ready to set initial positions for the controls on your mixer.

The front panel drawing on page 8 shows typical initial control positions which is a useful guide to setting up the mixer for the first time.

Set up individual input channel as follows:

- Connect your sources (microphone, keyboard etc.) to the required inputs.
WARNING: Phantom powered mics should be connected before the +48V is switched on. Ensure the PA system is OFF when switching phantom power on or off.
- Set Master faders at 0, input faders at 0, and set power amplifier levels to about 70%.
- Provide a typical performance level signal and press the PFL button on the first channel, monitoring the level on the bargraph meters.
- Adjust the input gain until the meter display is in the amber section, with occasional peaks to the first red LED at a typical maximum source level. This allows sufficient headroom to accommodate peaks and establishes the maximum level for normal operation (but see note below).
- Repeat this procedure on other channels as required. As more channels are added to the mix, the meters may move into the red section. Adjust the overall level using the Master Faders if necessary.
- Listen carefully for the characteristic sound of 'feedback'. If you cannot achieve satisfactory input level setting without feedback, check microphone and speaker placement and repeat the exercise. If feedback persists, it may be necessary to use a Graphic Equaliser to reduce the system response at particular resonant frequencies.

NOTE:

The initial settings should only be regarded as a starting point for your mix. It is important to remember that many factors affect the sound during a live performance, for instance the size of the audience!

Now ready to start building the mix and this should be done progressively,

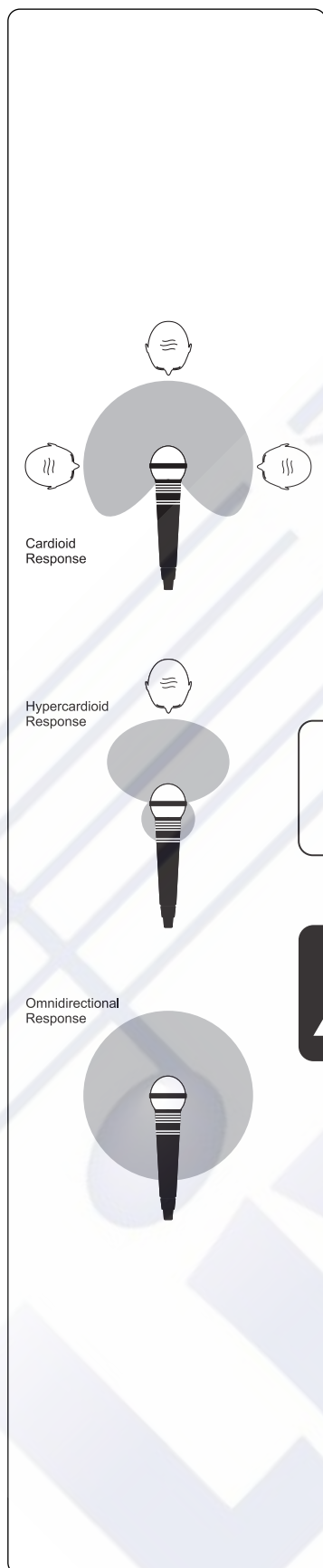

USER GUIDE

listening carefully for each component in the mix and watching the meters for any hint of overload. If this occurs, back off the appropriate Channel Fader slightly until the level is out of the red segments, or adjust the Master Faders.

Remember that the mixer is a mixer, not an amplifier. Increasing the overall level is the job of the amplifier, and if it is impossible to provide adequate level, it is probable that the amplifier is too small for the application. Choose your amplifier carefully, and do not try to compensate for lack of power by using the mixer to increase output level.

NOTE:



The level of any source signal in the final output is affected by many factors, principally the Input Gain control, Channel Fader and Mix Faders. You should try to use only as much microphone gain as required to achieve a good balance between signals, with the faders set as described above.

If the input gain is set too high, the channel fader will need to be pulled down too far in compensation to leave enough travel for successful mixing and there is a greater risk of feedback because small fader movements will have a very significant effect on output level. Also there will be a chance of distortion as the signal overloads the channel and causes clipping.

If the gain is set too low, you will not find enough gain on the faders to bring the signal up to an adequate level, and background hiss will be more noticeable.

This is illustrated below:

DIGITAL OUTPUT

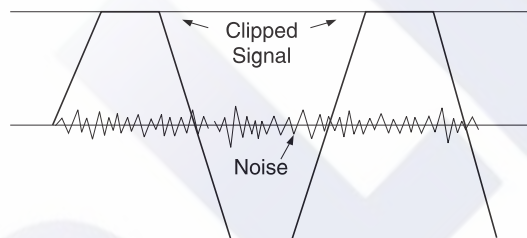

If the signal level is too high, clipping distortion may occur.

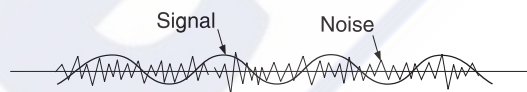

If the signal level is too low it may be masked by the noise.

SPIRIT M SERIES

Each of the models in the Spirit M Series is fitted with a digital output. The output conforms to the S/PDIF standard.

The S/PDIF output conforms to the consumer standard IEC958 1989-03, and also the Japanese standard EIAJ CP-340 1987-9

SPECIFICATION

Signal bit rate is 2.8Mhz based on the sampling frequency (Fs) of 44.1kHz

Physical connection:

Cable: 75Ω +/-5% ($l < 10m$) or 75Ω +/-35% ($l > 10m$)

Line driver:

Zout: 75Ω +/-20% (100kHz .. 6Mhz)

Vout: 0.4Vpp .. 0.6Vpp, $< 0.05Vdc$ (75Ω terminated)

SYNCHRONISATION

The digital output sample frequency is fixed 44.1kHz operation, when connecting to a piece of external equipment you must ensure that the two are synchronised.

There are two ways to achieve synchronisation when operating the Spirit M Series consoles:

1. Ensure the device receiving the digital signal is set to slave to the embedded clock in the S/PDIF output from your console.
2. Ensure the device receiving the digital signal is fitted with a sample rate converter, which eliminates the need for synchronisation.

DIGITAL AUDIO CABLE

S/PDIF (IEC-958) uses 75Ω coaxial cable and RCA connectors. 75Ω coaxial cable is inexpensive, because it is the same cable as used in video transmission (you can buy a video cable with RCA connectors to connect your S/PDIF equipment together). Coaxial S/PDIF connections work typically at least to 10-15 metre distances with good 75Ω coaxial cable.

REMEMBER:

The Soundcraft website will contain the latest set-up files for describing the synchronisation settings for many digital pieces of equipment.

<http://www.soundcraft.com>

USER GUIDE

RACKMOUNTING PROCEDURES FOR M8 AND M12

To turn the sleek looking Spirit M Series console into the rugged rackmount version follow the 3 point procedure below:

- A** Remove screws at points **A** and remove the arm rest.
- B** Remove screws at points **B** and remove the side extrusions.
- C** Remove the two screws at points **C** and remove both end-caps. Remember to re-fit the screws as they are used to strengthen the console.



Keep all parts and screws carefully in case you need to re-fit them at a later date.

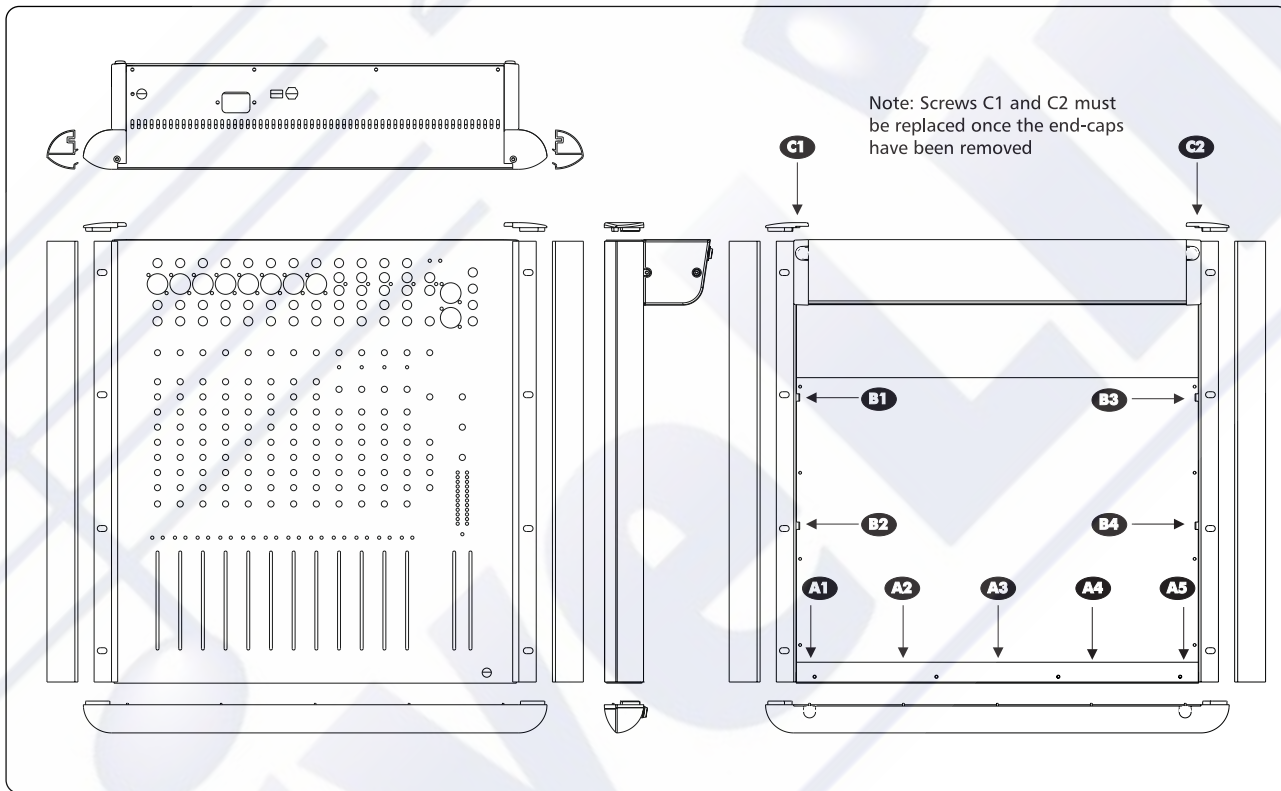

SPIRIT M SERIES

APPLICATION 1 - LIVE SOUND REINFORCEMENT

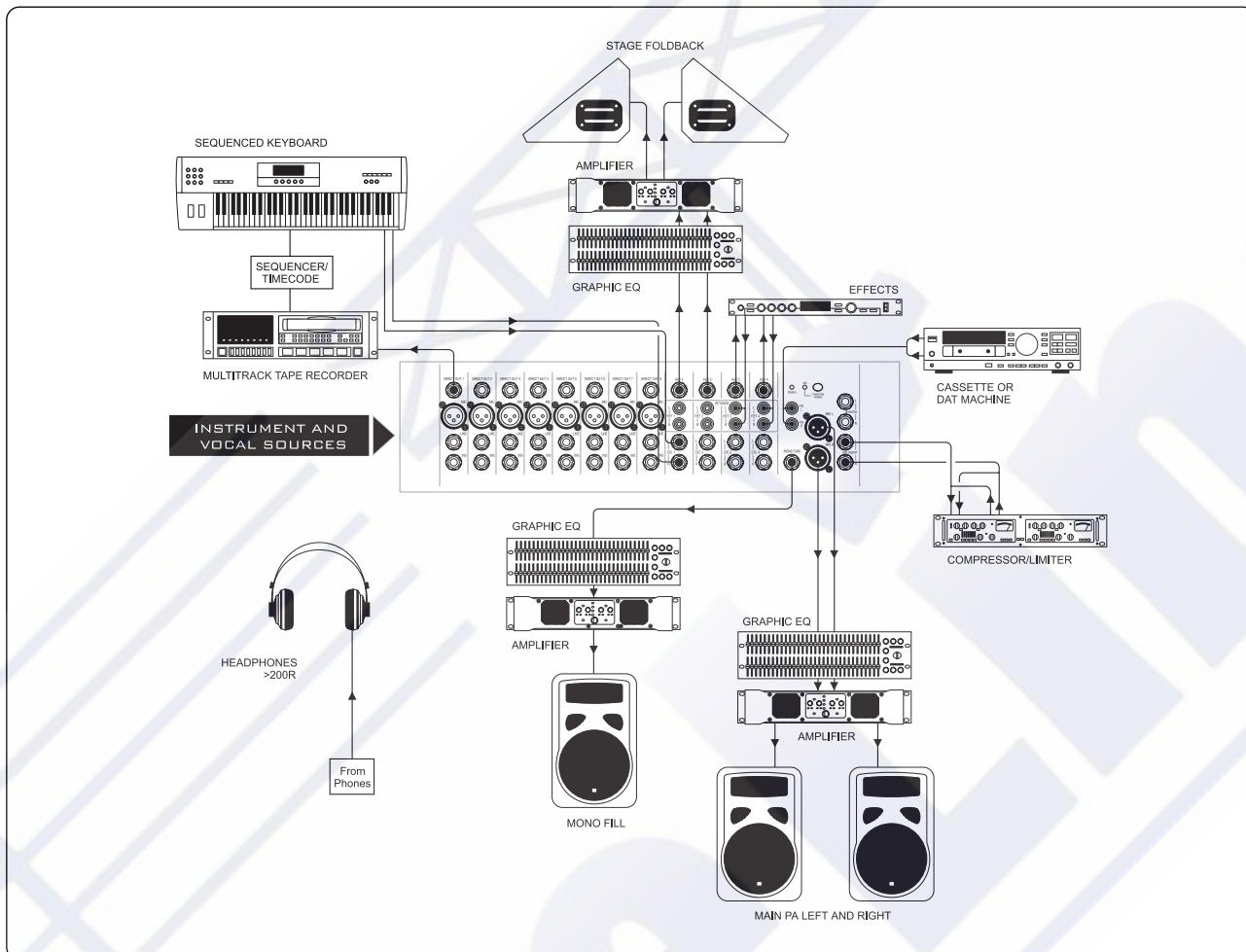

USING DELAY IN REINFORCEMENT SYSTEMS

The drawing below illustrates how to calculate delay settings for fill speakers in multiple speaker installations.

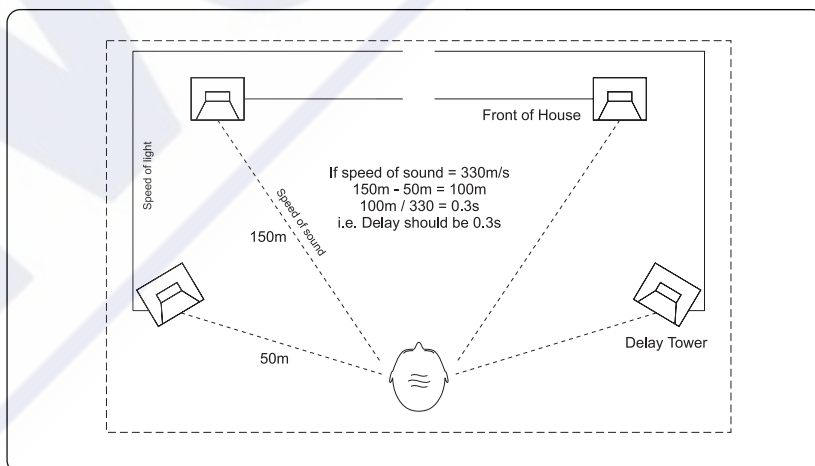

USER GUIDE

APPLICATION 2 - MULTISPEAKER APPLICATIONS

This configuration demonstrates how multiple speaker configurations can be driven by the Spirit M Range.

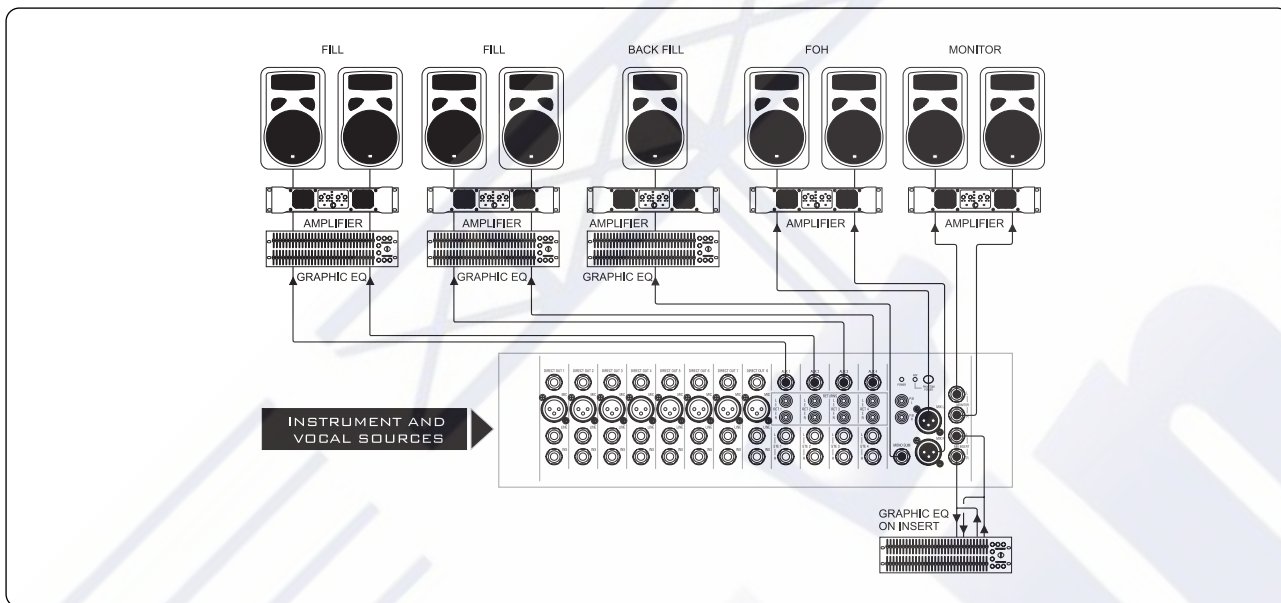

APPLICATION 3 - PLACES OF WORSHIP

This mono configuration uses the Mono output to drive the main speaker system and an induction loop for the hard of hearing. Aux sends are used for monitors and effects and Mix L & R feed a cassette or DAT machine to record the occasion if required.

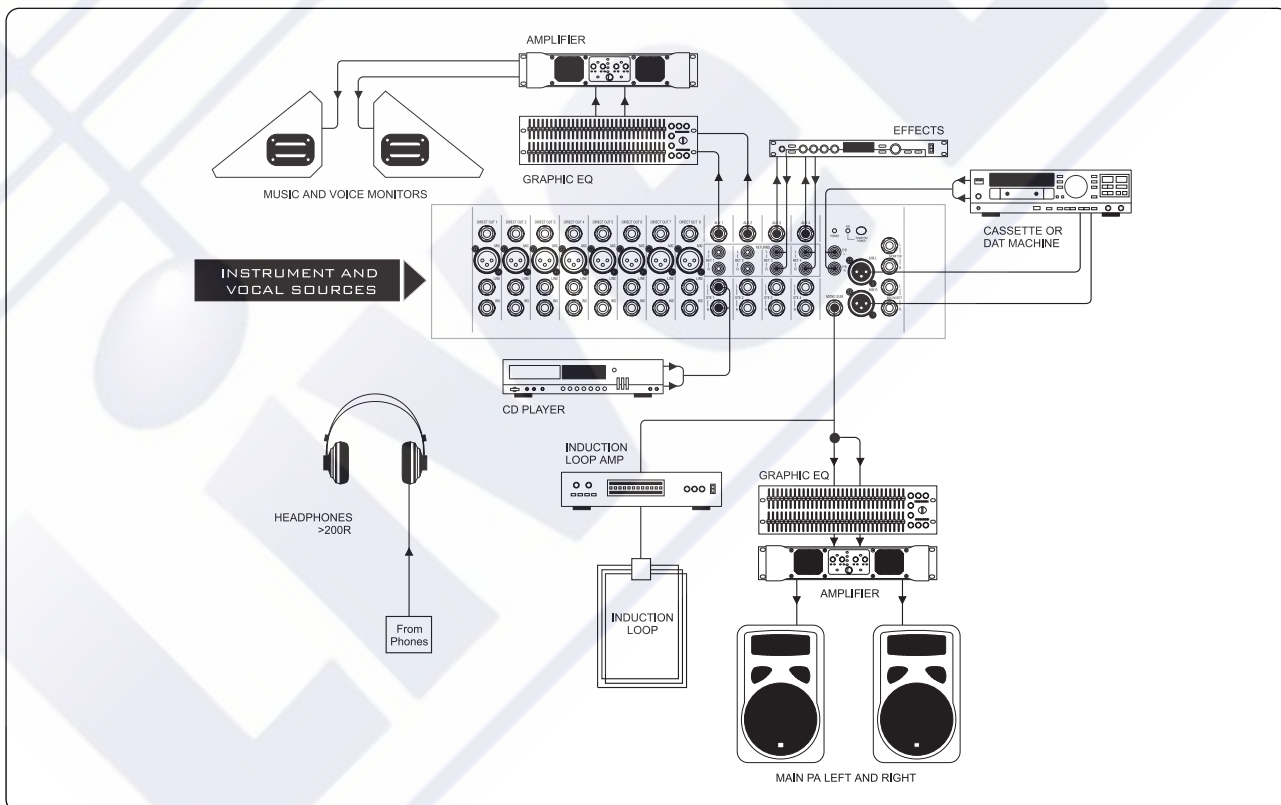

SPIRIT M SERIES

APPLICATION 4 - RECORDING

The direct outputs on channels 1-8 may be used to feed a multitrack recorder as shown. The direct outputs should be set to PRE, so that they are unaffected by fader position. The Mix outputs are used for a preliminary stereo mix on a DAT recorder.

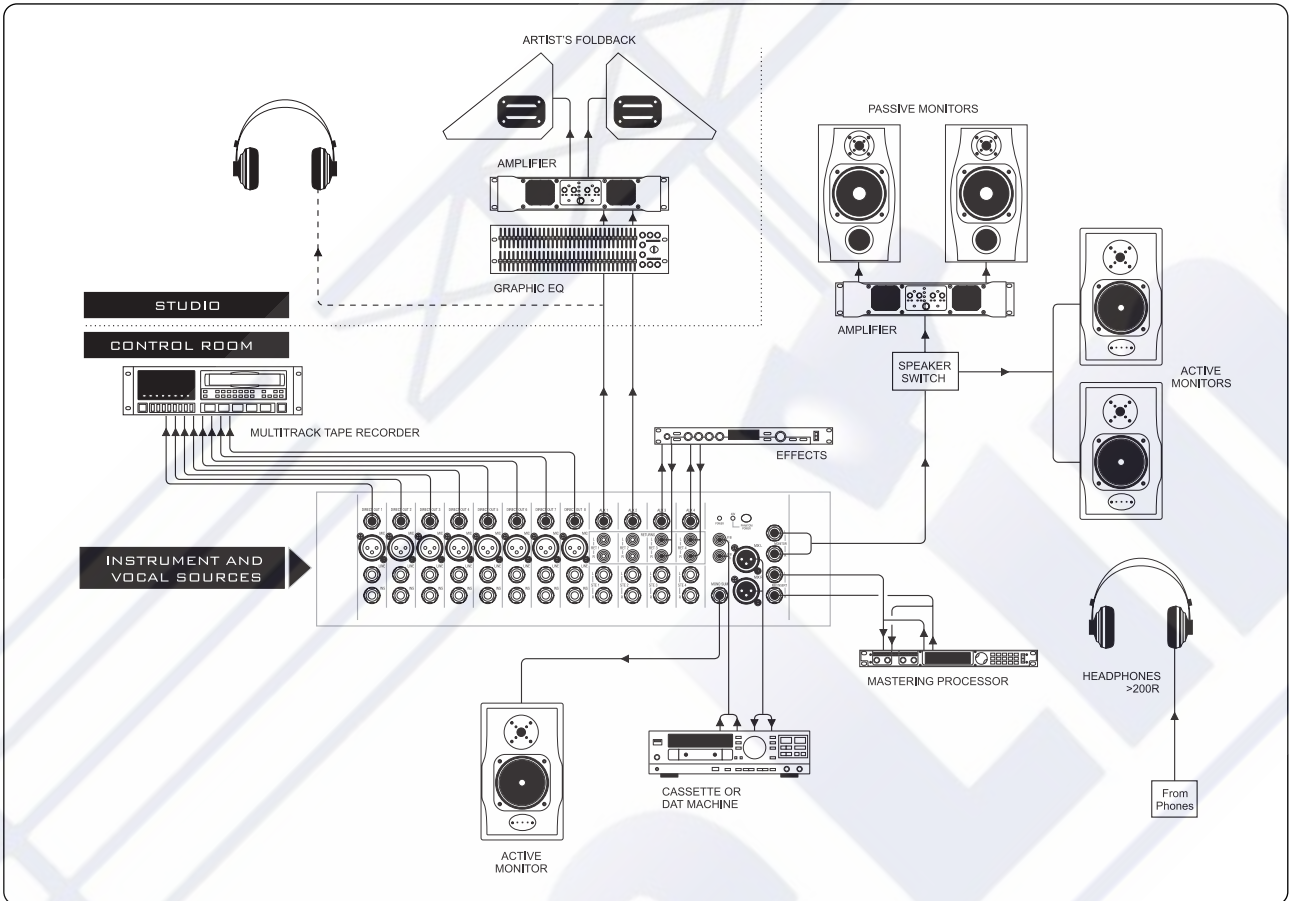

APPLICATION 5 - LINKING TWO SPIRIT M SERIES CONSOLES

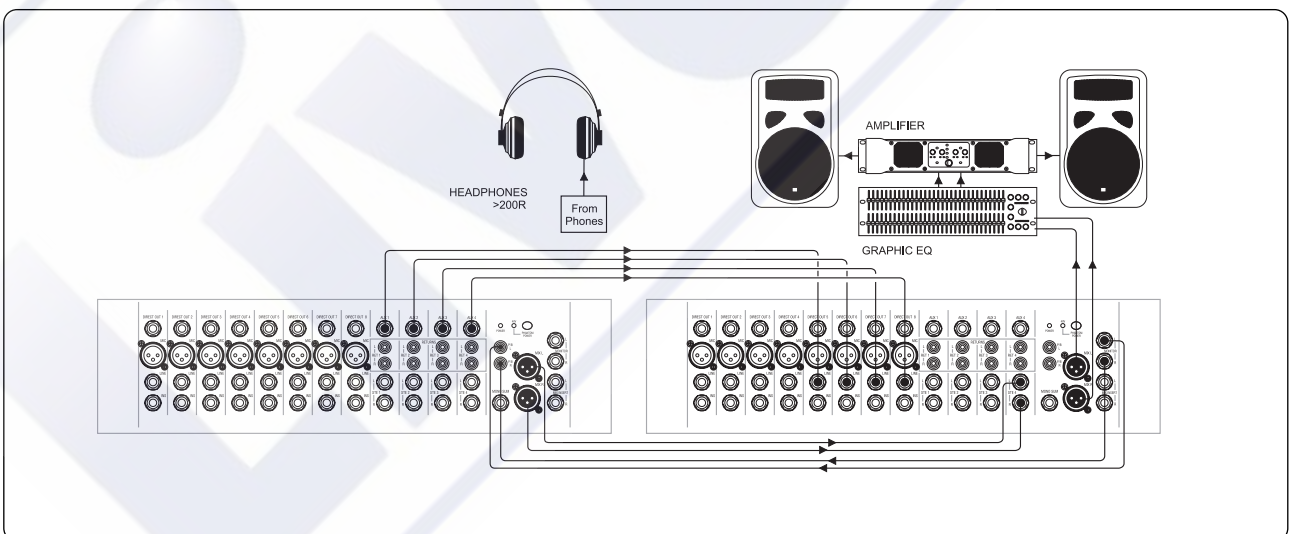

USER GUIDE

CARE OF YOUR MIXER



GENERAL PRECAUTIONS

Do Not obstruct any of the ventilation openings.

Avoid storing or using the mixer in conditions of excessive heat or cold, or in positions where it is likely to be subject to vibration, dust or moisture.

Keep the mixer clean using a soft dry brush, and an occasional wipe with a damp cloth or ethyl alcohol. Do not use any other solvents which may cause damage to paint or plastic parts.

Avoid placing drinks or smoking materials on or near the mixer. Sticky drinks and cigarette ash are frequent causes of damage to faders and switches.

Regular care and inspection will be rewarded by a long life and maximum reliability.

GLOSSARY

AFL (After Fade Listen)	a function that allows the operator to monitor the post-fade signal in a channel independently of the main mix.
auxiliary send	an output from the console comprising a mix of signals from channels and groups derived independently of the main stereo/group mixes. Typically the feeds to the mix are implemented on rotary level controls.
balance	the relative levels of the left and right channels of a stereo signal.
balanced	a method of audio connection which 'balances' the wanted signal between two wires and a screen which carries no signal. Any interference is picked up equally by the two wires, which results in cancellation of the unwanted signal. In this guide, the term can refer to various circuit architectures. Connection details are given in relevant sections.
clipping	the onset of severe distortion in the signal path, usually caused by the peak signal voltage being limited by the circuit's power supply voltage.
DAT	Digital Audio Tape, a cassette-based digital recording format.
dB (decibel)	a ratio of two voltages or signal levels, expressed by the equation $dB=20\log_{10}(V1/V2)$. Adding the suffix 'u' denotes the ratio is relative to 0.775V RMS.
DI(direct injection)/DI Box	the practice of connecting an electric musical instrument directly to the input of the mixing console, rather than to an amplifier and loudspeaker which is covered by a microphone feeding the console.
direct output	a post fade line level output from the input channel, bypassing the summing amplifiers, typically for sending to individual tape tracks during recording.
equaliser	a device that allows the boosting or cutting of selected bands of frequencies in the signal path.
fader	a linear control providing level adjustment.
feedback	the 'howling' sound caused by bringing a microphone too close to a loudspeaker driven from its amplified signal.
foldback	a feed sent back to the artistes via loudspeakers or headphones to enable them to monitor the sounds they are producing.
frequency response	the variation in gain of a device with frequency.
gain	the amount of amplification in level of the signal.
headroom	the available signal range above the nominal level before clipping occurs.
highpass filter	a filter that rejects low frequencies.
impedance balancing	a technique used on unbalanced outputs to minimise the effect of hum and interference when connecting to external balanced inputs.

SPIRIT M SERIES

insert	a break point in the signal path to allow the connection of external devices, for instance signal processors or other mixers at line level signals. Nominal levels can be anywhere between -10dBu to +6dBu, usually coming from a low impedance source.
pan (pot)	abbreviation of 'panorama': controls levels sent to left and right outputs.
peaking	the point at which a signal rises to its maximum instantaneous level, before falling back down again. It can also describe an equaliser response curve affecting only a band of frequencies, (like on a graphic equaliser), "peaking" at the centre of that band.
peak LED	a visual indication of the signal peaking just before the onset of clipping.
PFL (pre-fade listen)	a function that allows the operator to monitor the pre-fade signal in a channel independently of the main mix.
phase	a term used to describe the relationship of two audio signals. In-phase signals reinforce each other, out-of-phase signals result in cancellation.
polarity	a term used to describe the orientation of the positive and negative poles of an audio connection. Normally connections are made with positive to positive, negative to negative. If this is reversed, the result will be out-of-phase signals (see 'phase' above).
post-fade	the point in the signal path after the monitor or master fader and therefore affected by fader position.
pre-fade	the point in the signal path before the monitor or master fader position and therefore unaffected by the fader position.
rolloff	a fall in gain at the extremes of the frequency response.
shelving	an equaliser response affecting all frequencies above or below the break frequency i.e. a highpass or lowpass derived response.
spill	acoustic interference from other sources.
transient	a momentary rise in the signal level.
unbalanced	a method of audio connection which uses a single wire and the cable screen as the signal return. This method does not provide the noise immunity of a balanced input (see above).
+48V	the phantom power supply, available at the channel mic inputs, for condenser microphones and active DI boxes.

USER GUIDE

TYPICAL SPECIFICATIONS

FOR DIGITAL S/PDIF SPECIFICATIONS SEE P.25

NOISE
 Measured 22Hz to 22kHz, unweighted
 AUX & MIX O/Ps (8 Channels routed, faders down) <-84 dBu

E.I.N.
 Microphone Input
 (Maximum Gain, measured 22Hz - 22KHz, unweighted) -128 dBu

CROSSTALK 20Hz - 10kHz 10kHz - 20kHz
 Channel mute <90 dB <80 dB
 Fader cutoff (rel to 0 mark) <90dB <80dB
 Routing isolation <90dB <80dB

FREQUENCY RESPONSE
 Mic/Line Input to any output 20Hz to 20kHz ± 1 dB

T.H.D.
 Mic Gain. +30dBu, +20dBu at all outputs @ 1kHz < 0.008%

INPUT & OUTPUT IMPEDANCES
 Microphone Input ~ 2 k Ω
 Mono Channel Line Input >40 k Ω
 Stereo Input (Stereo Mode) >30 k Ω
 Stereo Returns >10 k Ω
 Headphones Output ~ 40 Ω
 All other audio outputs 75 Ω

INPUT & OUTPUT LEVELS
 Mic Input Maximum Level +12 dBu
 Mono Channel Line Input Maximum Level +38 dBu
 Insert Point Send / Return Levels +21dBu
 Stereo Input Maximum Level +21dBu
 Headphones (@200 Ω) 150mW
 All other audio outputs +21dBu into 10k Ω

FILTER
 High Pass 100Hz, 18dB/octave

EQ
 HF 12KHz, ± 15 dB
 MF 240Hz - 6KHz, ± 15 dB
 LF 60Hz, ± 15 dB

DIMENSIONS
 M4 (With Sides) W: 397 (15.6") x H: 119 (4.7") x D: 523 (20.6")
 M4 (No Sides) W: 373 (14.7") x H: 119 (4.7") x D: 490 (19.3")
 M8/12 (With Sides) W: 506 (19.9") x H: 119 (4.7") x D: 523 (20.6")
 M8/12 (No Sides, rackmount) W: 483 (19.0") x H: 119 (4.7") x D: 490 (19.3")

WEIGHT
 M4 6.75Kg (14.8lbs)
 M8 8.25Kg (18.1lbs)
 M12 8.55Kg (18.8lbs)

INRUSH CURRENT (M SERIES FAMILY)
 Worst Case: M12 @ 115V AC 4 Amps Peak

AVERAGE POWER CONSUMPTION (QUIESCENT)
 M4 19.51 Watts
 M8 24.48 Watts
 M12 30.00 Watts

MIN / MAX OPERATING TEMPERATURE (M SERIES FAMILY)
 Centigrade / Fahrenheit 0°C - 50°C / 32°F - 122°F

SPIRIT M SERIES

M8 & M12 DIMENSIONS

All dimensions are in millimetres (Inches shown in brackets).

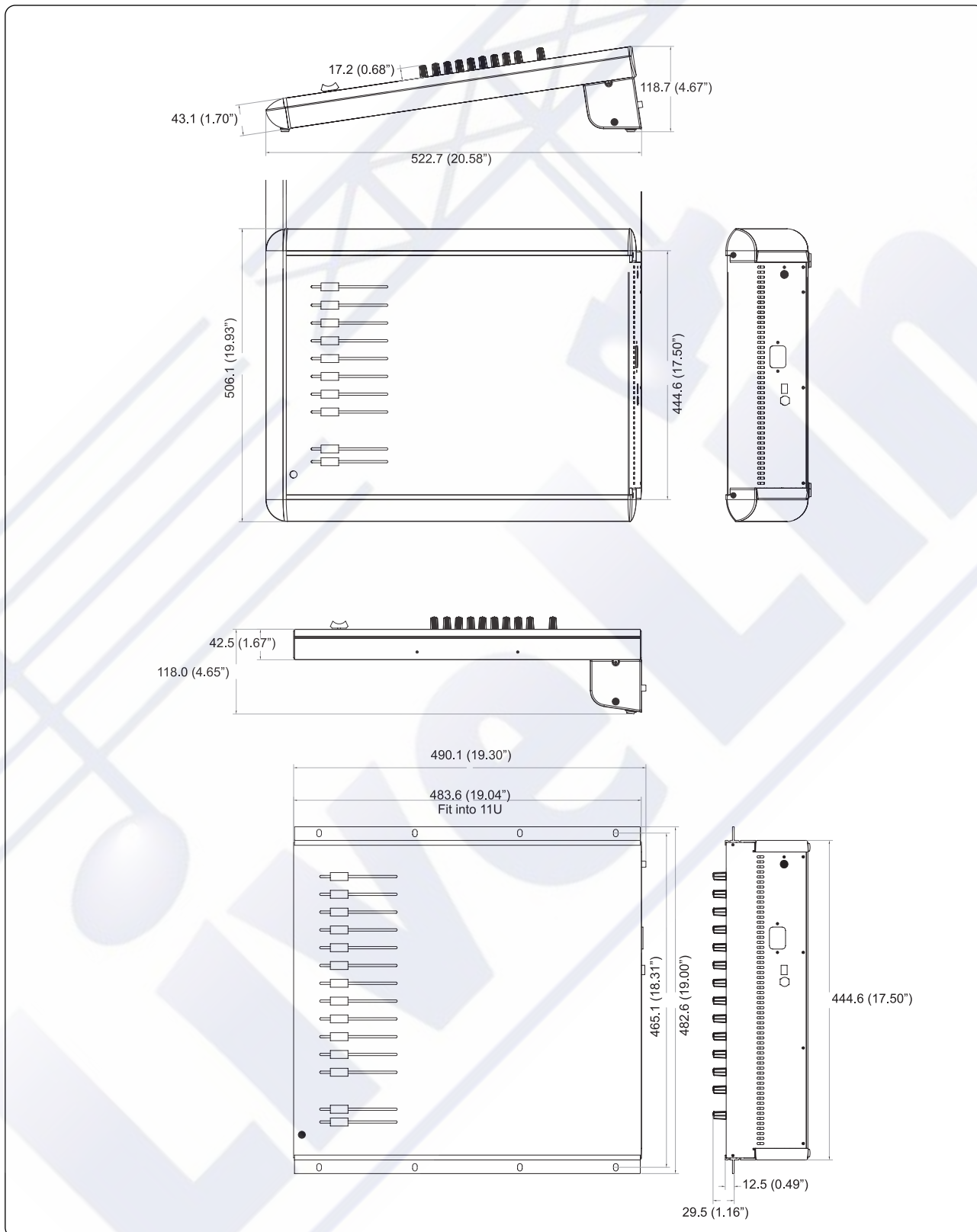

USER GUIDE

M4 DIMENSIONS

All dimensions are in millimetres (Inches shown in brackets).

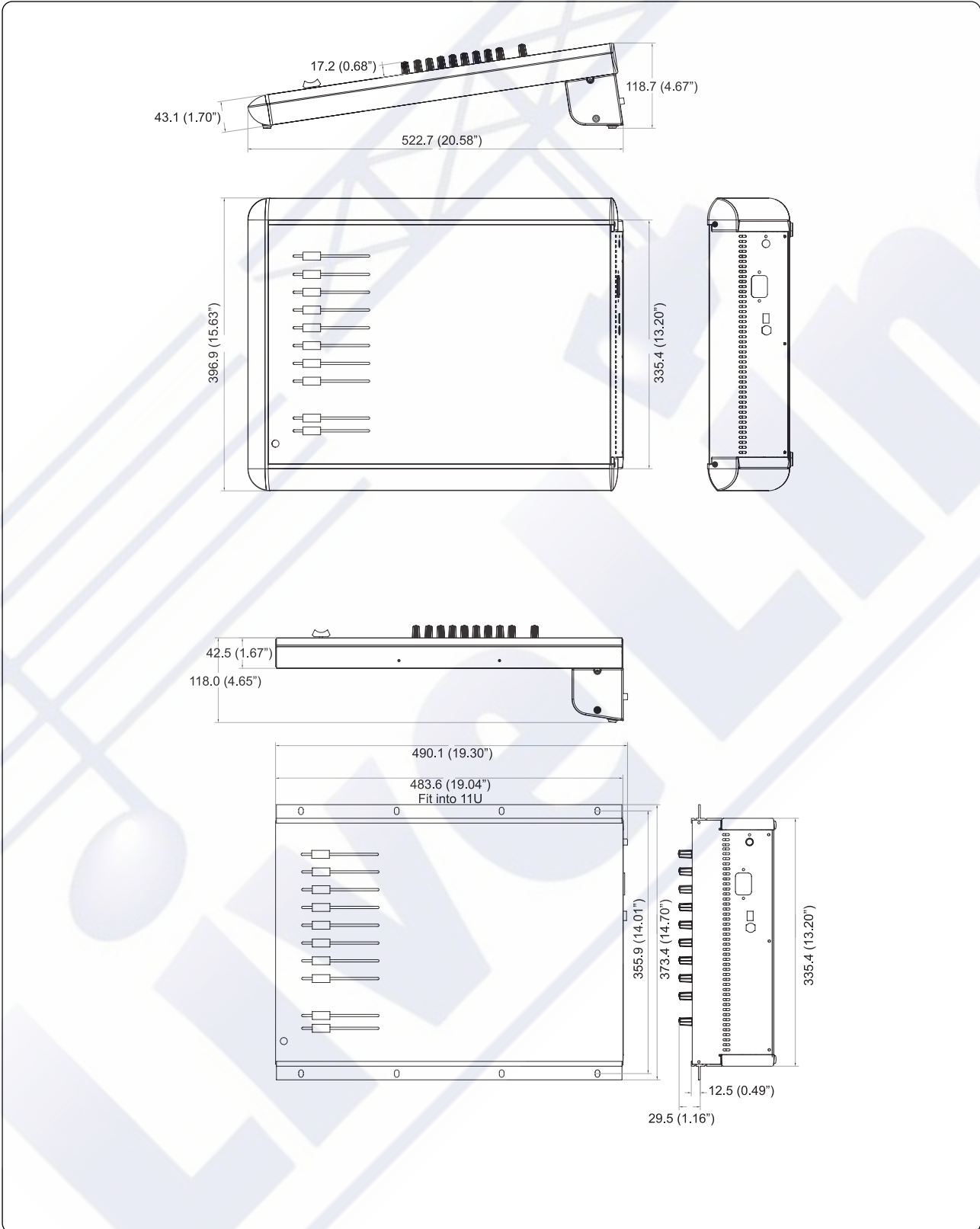

APPENDIX 1 - TYPICAL CONNECTING LEADS

Balanced - Line Inputs, Mix L & R Outputs, Stereo Inputs, Auxiliary Outputs

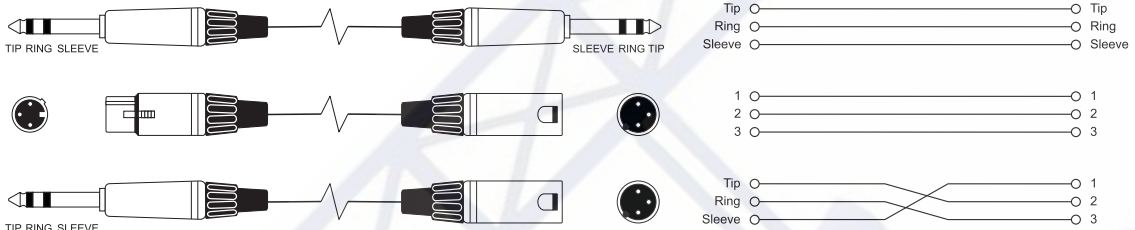

Unbalanced - Direct Output, Monitor Output, Stereo Return Inputs

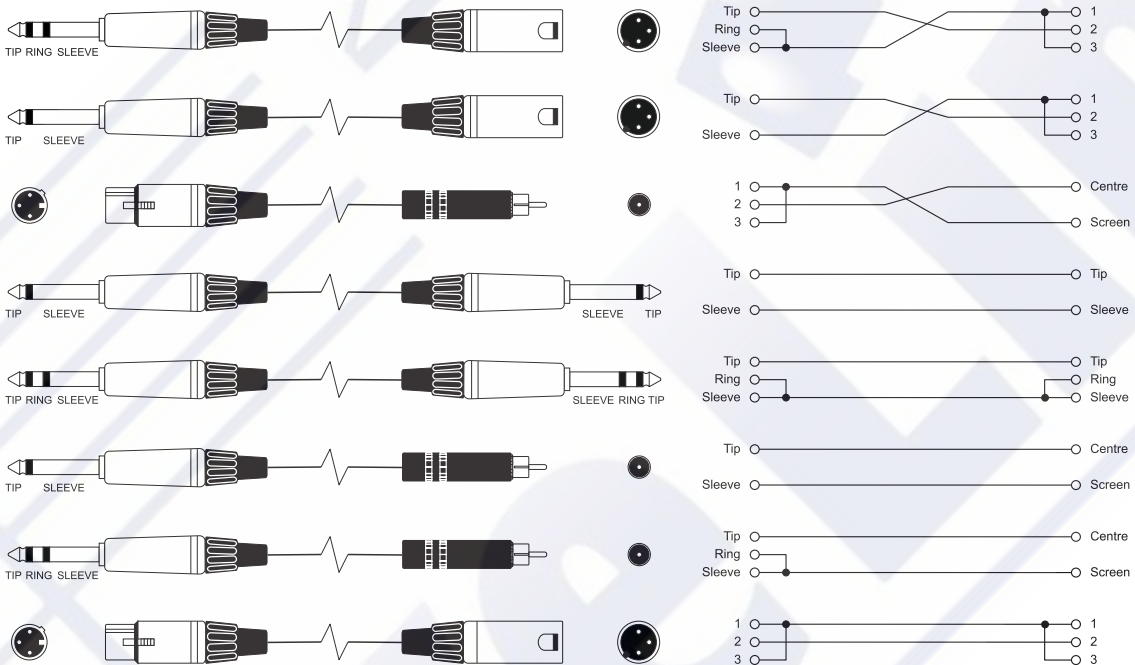

Insert Cables - Mono Inserts

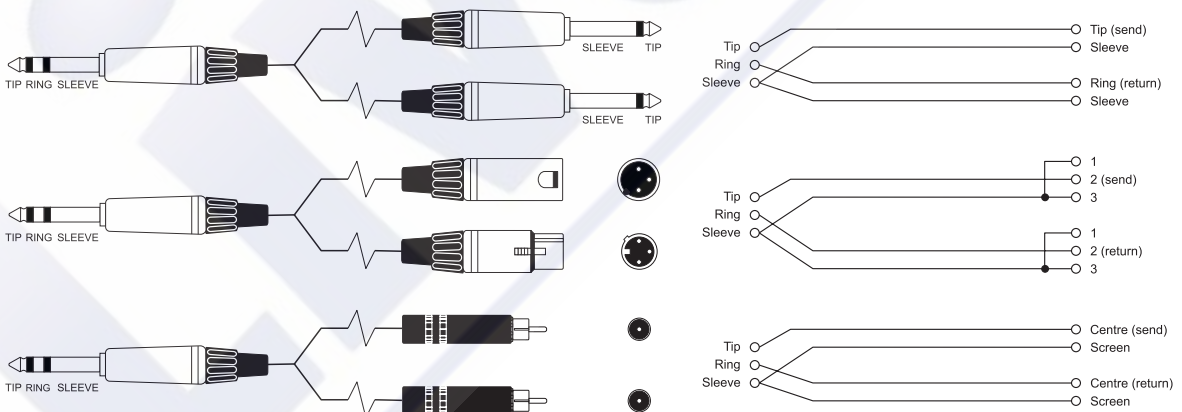

USER GUIDE

'Y' Cables (Balanced) Where used ... Aux, Mix outputs

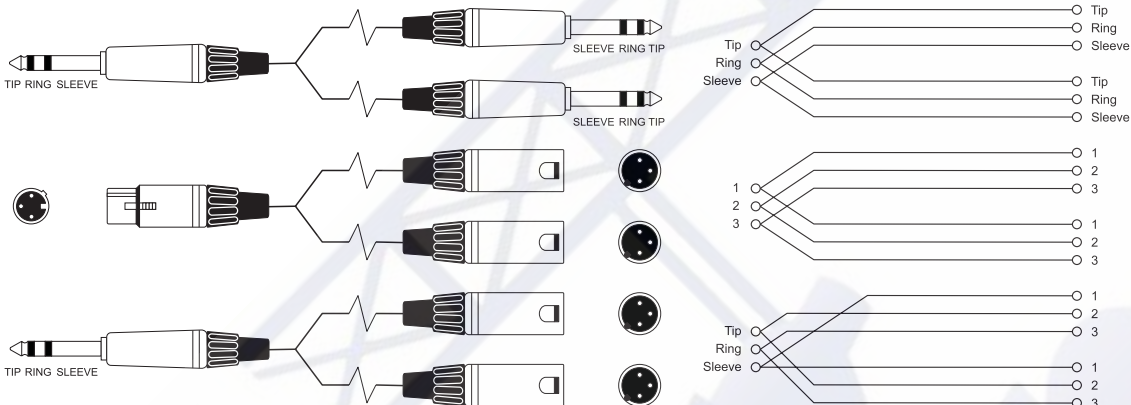

Headphone Separator Note: for every doubling of headphones the load impedance is halved. Do not go below 200R.

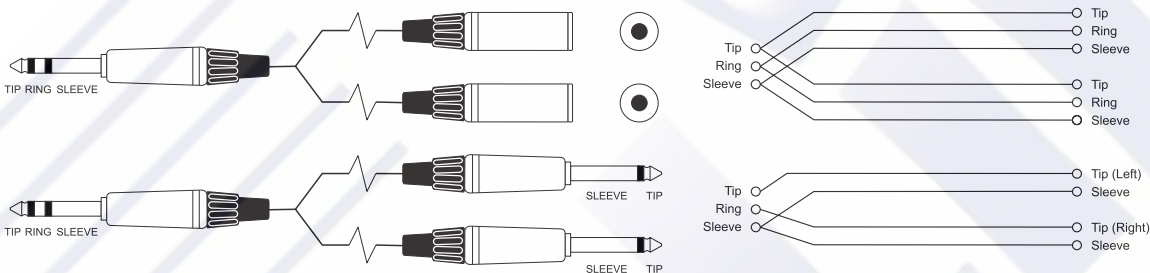

'Y' Cables (Unbalanced)

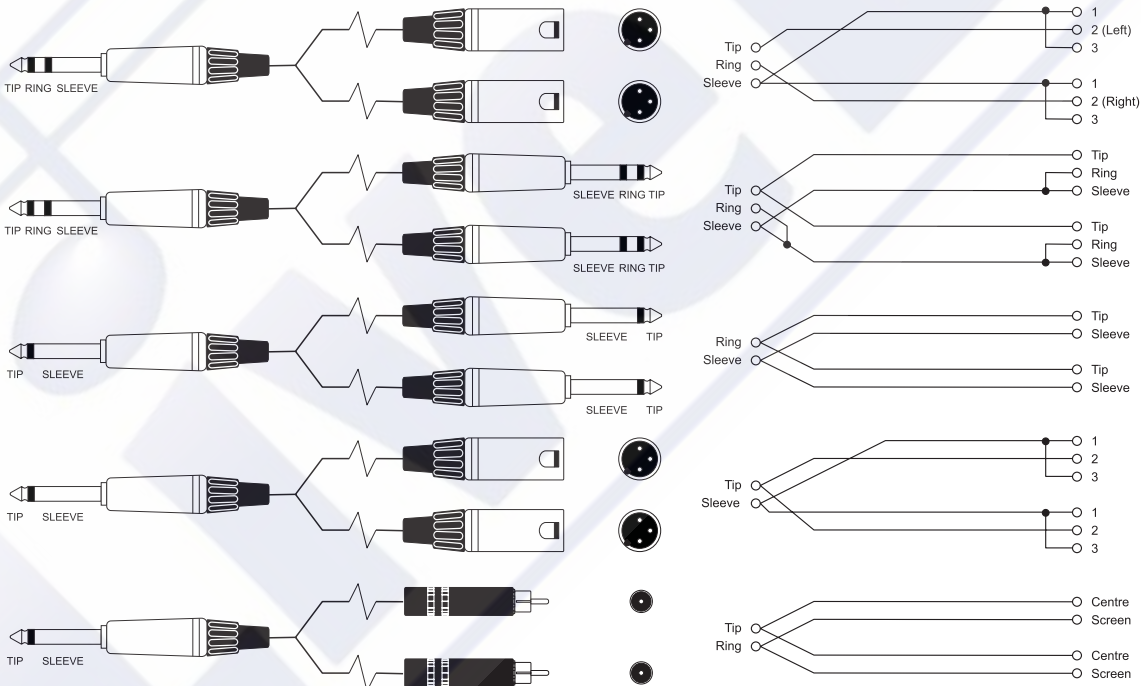

SYSTEM BLOCK DIAGRAM

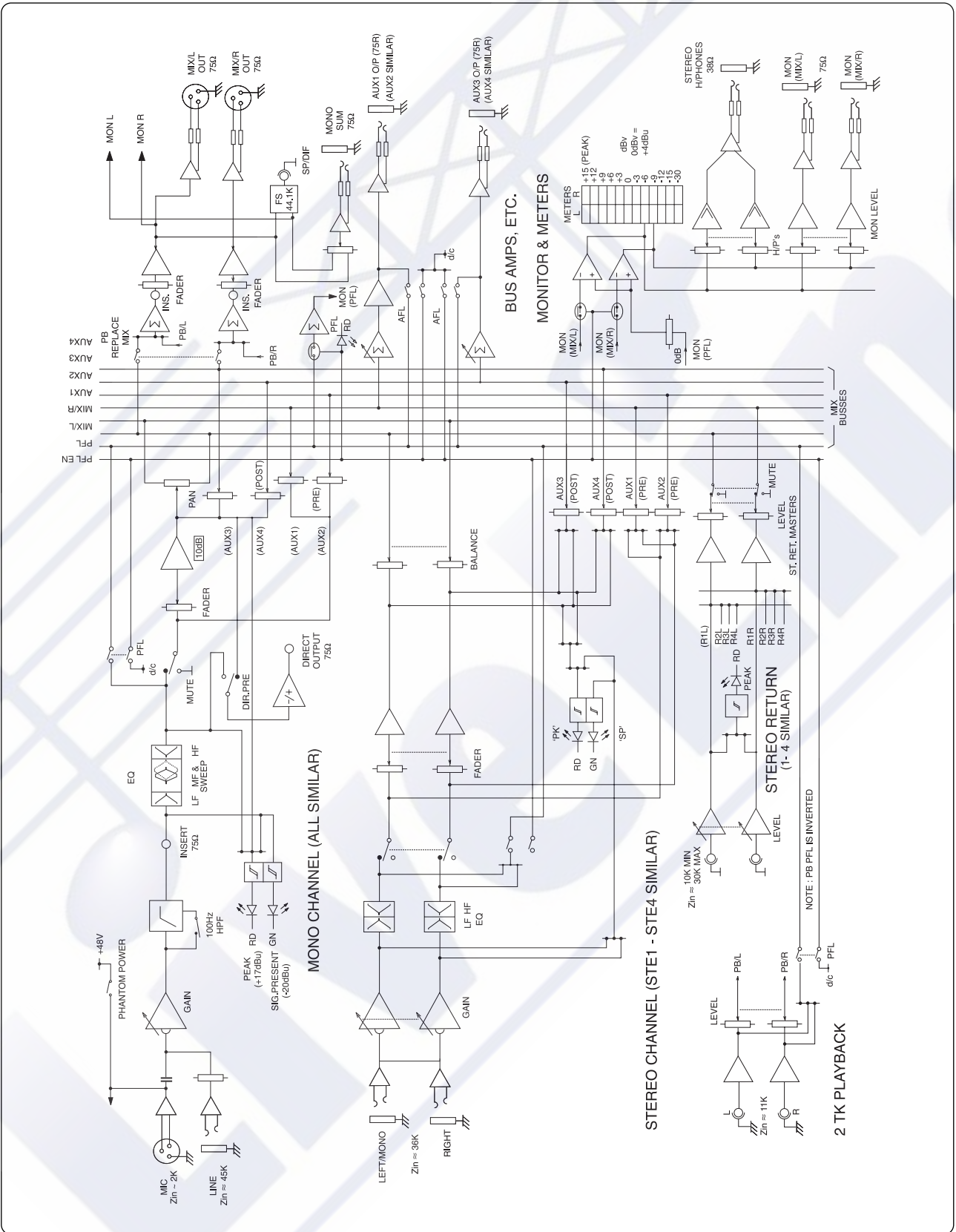

USER GUIDE



SPIRIT M SERIES



PHONES

CONTROL POSITION MARKUP SHEETS

To assist you in restoring the console to a previous setting, e.g. for different bands on a gig, you may photocopy these pages as many times as you like and use them for making a note of your control positions.

USER GUIDE



SPIRIT M SERIES

Channel 1-8: Each channel has a Gain knob (+10 to +30), a 100 Hz filter, HF (3-12 kHz), MID (240-6 kHz), and LF (3-15 kHz) frequency sliders, PRE and POST AUX 1-4 knobs, PAN (2-4) and BAL (1-5) knobs, MUTE, DIRECT, PFL, and PEAK buttons, and a vertical level meter (0 to ∞).

STEREO PAIRS (STE 1-4): Each stereo pair has a Gain knob (+11 to +22 dB), HF, MID, LF, PRE and POST AUX 1-4 knobs, PAN and BAL knobs, MUTE, PFL, and PEAK buttons, and a vertical level meter (0 to ∞).

MIX Section: Includes RETURN MASTER, P/B LEVEL, MONITOR, MONO SUM, P/B AFL, P/B REPLACE MIX, AUX MAST 1-4, PHONES (L, R), and SOLO AFL/PFL buttons. It also features a vertical level meter (0 to ∞).



CONTROL POSITION MARKUP SHEETS

To assist you in restoring the console to a previous setting, e.g. for different bands on a gig, you may photocopy these pages as many times as you like and use them for making a note of your control positions.

USER GUIDE



SPiRiT M SERIES

SPiRiT M12 DIGITAL L-O-U-T

RETURN MASTER (0-10), MUTE (○), P/B LEVEL (0-10), P/B PEFL (○), P/B REPLACE MKX (0-10), PHONES (0-10), AUX MAST (1-4), APL (1-4), MUTE, PFL, PEAK, SUB, DIRECT PAIR.

RET 4 (0-10), RET 3 (0-10), RET 2 (0-10), RET 1 (0-10).

Channel	GAIN (0-10)	TID HF (0-100)	HF (0-12)	HF (0-12)	MID (0-12)	LF (0-12)	PRE (0-10)	AUX (1-4)	POST (1-4)	PEAK	Sub	Direct Pair	12	11	10	9	8	7	6	5	4	3	2	1	STE 1	STE 2	STE 3	STE 4	MIX								
1	GAIN	TID	HF	HF	MID	LF	PRE	AUX	POST	PEAK	Sub	Direct Pair																									
2	GAIN	TID	HF	HF	MID	LF	PRE	AUX	POST	PEAK	Sub	Direct Pair																									
3	GAIN	TID	HF	HF	MID	LF	PRE	AUX	POST	PEAK	Sub	Direct Pair																									
4	GAIN	TID	HF	HF	MID	LF	PRE	AUX	POST	PEAK	Sub	Direct Pair																									
5	GAIN	TID	HF	HF	MID	LF	PRE	AUX	POST	PEAK	Sub	Direct Pair																									
6	GAIN	TID	HF	HF	MID	LF	PRE	AUX	POST	PEAK	Sub	Direct Pair																									
7	GAIN	TID	HF	HF	MID	LF	PRE	AUX	POST	PEAK	Sub	Direct Pair																									
8	GAIN	TID	HF	HF	MID	LF	PRE	AUX	POST	PEAK	Sub	Direct Pair																									
9	GAIN	TID	HF	HF	MID	LF	PRE	AUX	POST	PEAK	Sub	Direct Pair																									
10	GAIN	TID	HF	HF	MID	LF	PRE	AUX	POST	PEAK	Sub	Direct Pair																									
11	GAIN	TID	HF	HF	MID	LF	PRE	AUX	POST	PEAK	Sub	Direct Pair																									
12	GAIN	TID	HF	HF	MID	LF	PRE	AUX	POST	PEAK	Sub	Direct Pair																									

RETURN MASTER (0-10), MUTE (○), P/B LEVEL (0-10), P/B PEFL (○), P/B REPLACE MKX (0-10), PHONES (0-10), AUX MAST (1-4), APL (1-4), MUTE, PFL, PEAK, SUB, DIRECT PAIR.



CONTROL POSITION MARKUP SHEETS

To assist you in restoring the console to a previous setting, e.g. for different bands on a gig, you may photocopy these pages as many times as you like and use them for making a note of your control positions.

USER GUIDE



Soundcraft
Harman International Industries Limited
Cranborne House
Cranborne Road
Potters Bar
Hertfordshire
EN6 3JN, UK

Tel: +44 (0) 1707 665000
Fax: +44 (0) 1707 660742
Email: spiritinfo@soundcraft.com

Soundcraft USA
1449 Donelson Pike
Nashville, TN 37217
USA

Tel: 1 615-360-0707
Toll free: 1 800-255-4363
Fax: 1 615-360-0273
Email: soundcraft-usa@harman.com

Soundcraft reserve the right to improve or otherwise alter any information
supplied in this document or any other document supplied hereafter.
E&OE 09/00.

H A Harman International Company



Part No: ZM0252
Issue: 1.2

