

Pioneer



DVD PLAYER

DVD-V7300D

Operating Instructions

www.liveline.be



IMPORTANT



The lightning flash with arrowhead symbol, within an equilateral triangle, is intended to alert the user to the presence of uninsulated "dangerous voltage" within the product's enclosure that may be of sufficient magnitude to constitute a risk of electric shock to persons.

CAUTION

RISK OF ELECTRIC SHOCK
DO NOT OPEN



CAUTION:
TO PREVENT THE RISK OF ELECTRIC SHOCK,
DO NOT REMOVE COVER (OR BACK). NO
USER-SERVICEABLE PARTS INSIDE. REFER
SERVICING TO QUALIFIED SERVICE
PERSONNEL.

The exclamation point within an equilateral triangle is intended to alert the user to the presence of important operating and maintenance (servicing) instructions in the literature accompanying the appliance.

IMPORTANT

FOR USE IN THE UNITED KINGDOM

The wires in this mains lead are coloured in accordance with the following code:

blue: neutral

brown: live

If the plug provided is unsuitable for your socket outlets, the plug must be cut off and a suitable plug fitted.

The cut-off plug should be disposed of and must not be inserted into any 13 amp socket as this can result in electric shock. The plug or adaptor of the distribution panel should be provided with 13 amp fuse. As the colours of the wires in the mains lead of this appliance may not correspond with coloured marking identifying the terminals in your plug, proceed as follows:

The wire which is coloured blue must be connected to the terminal which is marked with the letter N or coloured black.

The wire which is coloured brown must be connected to the terminal which is marked with the letter L or coloured red.

Do not connect either wire to the earth terminal of a three pin plug.

NOTE

After replacing or changing a fuse, the fuse cover in the plug must be replaced with a fuse cover which corresponds to the colour of the insert in the base of the plug or the word that is embossed on the base of the plug, and the appliance must not be used without a fuse cover. If lost, replacement fuse covers can be obtained from your dealer. This appliance is rated approved to B.S. 1362 A.S.T.A. should be used.

Bij dit product zijn batterijen geleverd. Wanneer deze leeg zijn, moet u ze niet weggooien maar inleveren als KCA.

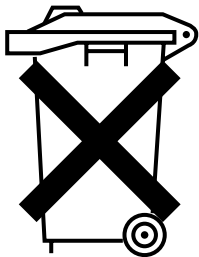

IMPORTANT

CAUTION

This product contains a laser diode of higher class than 1. To ensure continued safety, do not remove any covers or attempt to gain access to the inside of the product. Refer all servicing to qualified personnel.

The following caution label appear on the player.

Location: On the bonnet of the player

CLASS 1
LASER PRODUCT

DRW1995-A

CAUTION : VISIBLE AND INVISIBLE LASER RADIATION WHEN OPEN.
AVOID EXPOSURE TO BEAM.

VORSICHT : SICHTBARE UND UNSICHTBARE LASERSTRAHLUNG, WENN
ABDECKUNG GEÖFFNET NICHT DEM STRAHL AUSSETZEN!

ADVARSEL : SYNLIG OG USYNLIG LASERSTRÅLING VED ÅBNING
UNDGÅ UDSÆTTELSE FOR STRÅLING.

VARNING : SYNLIG OCH OSYNLIG LASERSTRÅLNING NÄR DENNA
DEL ÄR ÖPPNAD BETRakta EJ STRÅLEN.

VARO! : AVATTAESSA ALTISTUT NÄKYVÄ JA NÄKYMÄTTÖMÄLLE
LASERSATEIL YLLE. ÄLÄ KATSO SÄTEESÄN.

VRW1699

This product complies with the Low Voltage Directives (73/23/EEC) . EMC Directives (89/336/EEC, 92/31/EEC) and CE Marking Directive (93/68/EEC).

WARNING: TO PREVENT FIRE OR SHOCK HAZARD, DO NOT EXPOSE THIS APPLIANCE TO RAIN OR MOISTURE.

CONSULT WITH THE COMPANY SALES REPRESENTATIVE. "USE ONLY SAFETY LICENCED POWER SUPPLY CORD."

A CERTIFIED POWER SUPPLY CORD IS TO BE USED WITH THIS EQUIPMENT. FOR A RATED CURRENT UP TO 6 A, A TYPE NOT LIGHTER THAN H05VV-F 3G 0.75 mm² SHALL BE USED.

The generation of Acoustial Noise Is Less Than 70 dB.
(ISO 7779/DIN 45635)

The stand-by/ ON switch is secondary connected and therefore, does not separate the unit from mains power in standby position.

Français

IMPORTANT

ATTENTION

Ce produit renferme une diode à laser d'une catégorie supérieure à 1. Pour garantir une sécurité constante, ne pas retirer les couvercles ni essayer d'accéder à l'intérieur de l'appareil.

Pour toute réparation, s'adresser à un personnel qualifié.

La note suivante se trouve sur votre lecteur.

Emplacement : Sur le couvercle du lecteur

CLASS 1
LASER PRODUCT

DRW1995-A

CAUTION : VISIBLE AND INVISIBLE LASER RADIATION WHEN OPEN.
AVOID EXPOSURE TO BEAM.

VORSICHT : SICHTBARE UND UNSICHTBARE LASERSTRAHLUNG, WENN
ABDECKUNG GEÖFFNET NICHT DEM STRAHL AUSSETZEN!

ADVARSEL : SYNLIG OG USYNLIG LASERSTRÅLING VED ÅBNING
UNDGÅ UDSÆTTELSE FOR STRÅLING.

VARNING : SYNLIG OCH OSYNLIG LASERSTRÅLNING NÄR DENNA
DEL ÄR ÖPPNAD BETRakta EJ STRÅLEN.

VARO! : AVATTAESSA ALTISTUT NÄKYVÄ JA NÄKYMÄTTÖMÄLLE
LASERSATEIL YLLE. ÄLÄ KATSO SÄTEESÄN.

VRW1699

Ce produit est conforme à la directive relative aux appareils basse tension (73/23/CEE), aux directives relatives à la compatibilité électromagnétique (89/336/CEE, 92/31/CEE) et à la directive CE relative aux marquages (93/68/CEE).

ATTENTION: AFIN DE PREVENIR TOUT RISQUE DE CHOC ELECTRIQUE OU D'INCENDIE, NE PAS EXPOSER CET APPAREIL A L'HUMIDITE NI A LA PLUIE.

CONSULTER UN AGENT COMMERCIAL DE LA SOCIETE.

**"N'UTILISER QU'UN CORDON D'ALIMENTATION GARANTISSANT LA SECURITE".
UN CORDON D'ALIMENTATION HOMOLOGUE DOIT ETRE UTILISE AVEC CET APPAREIL. POUR UN COURANT NOMINAL DE JUSQU'A 6 A, IL FAUT UTILISER UN TYPE DE CORDON QUI NE SOIT PAS INFÉRIEUR A H05VV-F 3G 0,75 mm² OU H05VVH2-F 3G 0,75 mm².**

La génération de bruit de fond acoustique est inférieure à 70 dB. [ISO 7779/DIN45635]

L'interrupteur Veille/ON est à raccordement secondaire et il ne coupe donc pas totalement l'appareil de l'alimentation secteur sur la position de veille.

WICHTIG**VORSICHT**

Dieses Gerät enthält eine Laserdiode mit einer höheren Klasse als 1. Um einen stets sicheren Betrieb zu gewährleisten, weder irgendwelche Abdeckungen entfernen, noch versuchen, sich zum Geräteinneren Zugang zu verschaffen.

Alle Wartungsarbeiten sollten qualifiziertem Kundendienstpersonal überlassen werden.

Die folgenden Warnungsetiketten sind am DVD-Spieler angebracht.

Lage: Auf der Haube des Players

**CLASS 1
LASER PRODUCT**

DRW1995-A

CAUTION : VISIBLE AND INVISIBLE LASER RADIATION WHEN OPEN.
· AVOID EXPOSURE TO BEAM.

VORSICHT : SICHTBARE UND UNSICHTBARE LASERSTRAHLUNG, WENN ABDECKUNG GEÖFFNET NICHT DEM STRAHL AUSSETZEN!

ADVARSEL : SYNLIG OG USYNLIG LASERSTRÅLING VED ÅBNING
· UNGDÅ UDSÆTTELSE FOR STRÅLING.

VARNING : SYNLIG OCH OSYNLIG LASERSTRÅLNING NÄR DENNA
· DEL ÄR ÖPPNAD BETRAKTA EJ STRÅLEN.

VARO! : AVATTAESSA ALTISTUT NÄKYVÄ JA NÄKYMÄTTÖMÄLLE
· LASERSATEIL YLLE. ÄLÄ KATSO SÄTEESEN.

VRW1699

Dieses Produkt entspricht den Niederspannungsrichtlinien (73/23/EC), EMV-Richtlinien (89/336/EEC, 92/31/EEC) und den CE-Markierungsrichtlinien (93/68/EEC).

WARNUNG: UM EINEN BRAND ODER STROMSCHLAG ZU VERMEIDEN, DIESES GERÄT NICHT REGEN ODER FEUCHTIGKEIT AUSSETZEN.

“AUSSCHLIESSLICH EIN DEN GELTENDEN SICHERHEITSBESTIMMUNGEN ENTSPRECHENDES NETZKABEL VERWENDEN.”

DIESES GERÄT MUSS ÜBER EIN DEN GELTENDEN SICHERHEITSBESTIMMUNGEN ENTSPRECHENDES NETZKABEL AN DAS STROMNETZ

ANGESCHLOSSEN WERDEN. BEI EINEM NENNSTROM VON MAXIMAL 6 A MUSS EINE NETZKABELGARNITUR VON MINDESTENS H05VV-F 3 G 0,75 mm² ODER H05VVH2-F 3 G 0,75 mm² VERWENDET WERDEN.

Der Betriebsgeräuschpegel beträgt weniger als 70 dB [ISO 7779/DIN 45635].

Der Bereitschafts-/Ein-Schalter ist sekundär angeschlossen, und trennt das Gerät in der Bereitschaftsstellung nicht vom Stromnetz.

IMPORTANTE**PRECAUZIONE**

Questo prodotto contiene un diodo al laser di classe superiore alla classe 1. Per motivi di sicurezza, non smontare i coperchi e non procedere ad interventi sulle parti interne.

Per qualsiasi riparazione rivolgersi a personale qualificato.

La nota seguente si trova.

Ubicazione: Sul coperchio del lettore

**CLASS 1
LASER PRODUCT**

DRW1995-A

CAUTION : VISIBLE AND INVISIBLE LASER RADIATION WHEN OPEN.
· AVOID EXPOSURE TO BEAM.

VORSICHT : SICHTBARE UND UNSICHTBARE LASERSTRAHLUNG, WENN ABDECKUNG GEÖFFNET NICHT DEM STRAHL AUSSETZEN!

ADVARSEL : SYNLIG OG USYNLIG LASERSTRÅLING VED ÅBNING
· UNGDÅ UDSÆTTELSE FOR STRÅLING.

VARNING : SYNLIG OCH OSYNLIG LASERSTRÅLNING NÄR DENNA
· DEL ÄR ÖPPNAD BETRAKTA EJ STRÅLEN.

VARO! : AVATTAESSA ALTISTUT NÄKYVÄ JA NÄKYMÄTTÖMÄLLE
· LASERSATEIL YLLE. ÄLÄ KATSO SÄTEESEN.

VRW1699

Questo prodotto è conforme alla direttiva sul basso voltaggio (73/23/CEE), alle direttive EMC (89/336/CEE, 92/31/CEE) e alla direttiva sul marchio CE (93/68/CEE).

AVVERTENZA: PER EVITARE IL RISCHIO DI FIAMME O SCOSSE ELETTRICHE, NON ESPORRE QUESTO APPARECCHIO ALLA PIOGGIA O ALL'UMIDITÀ

CONSULTARE IL RAPPRESENTANTE DELLA COMPAGNIA. “USARE SOLTANTO IL CAVO DI ALIMENTAZIONE BREVETTATO PER LA SICUREZZA.” CON QUESTO APPARECCHIO SI DEVE USARE UN CAVO DI ALIMENTAZIONE CERTIFICATO. PER UNA CORRENTE NOMINALE FINO A 6 A, DEVE ESSERE USATO UN TIPO NON PIÙ LEGGERO DI H05VV-F 3G 0,75 mm² O H05VVH2-F 3G 0,75 mm².

La generazione di rumore acustico è inferiore a 70 dB. (ISO 7779/DIN45635)

L'interruttore di attesa/accensione (ON) è collegato in modo secondario e perciò nella posizione di attesa non separa l'unità dall'alimentazione della rete.

IMPORTANTE**PRECAUCIÓN**

Este producto contiene un diodo de láser de clase superior a 1. Para mantener la seguridad apropiada, no quite ninguna tapa ni trate de acceder al interior del aparato. Confíe todo el mantenimiento a personal técnico cualificado.

En su aparato se han aplicado las siguientes etiquetas precautorias:

Ubicación: En la cubierta del reproductor

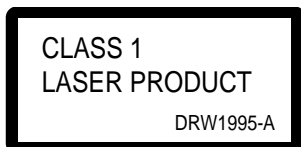

CAUTION : VISIBLE AND INVISIBLE LASER RADIATION WHEN OPEN. AVOID EXPOSURE TO BEAM.

VORSICHT : SICHTBARE UND UNSICHTBARE LASERSTRAHLUNG, WENN ABDECKUNG GEÖFFNET NICHT DEM STRAHL AUSSETZEN!

ADVARSEL : SYNLIG OG USYNLIG LASERSTRÅLING VED ÅBNING
UNDGÅ UDSÆTTELSE FOR STRÅLING.

VARNING : SYNLIG OCH OSYNLIG LASERSTRÅLNING NÄR DENNA
DEL ÄR ÖPPNAD BETRakta EJ STRÅLEN.

VARO! : AVATTAESSA ALTISTUT NÄKYVÄ JA NÄKYMÄTTÖMÄLLE
LASERSATEIL YLLE. ÄLÄ KATSO SÄTEESSEN.

VRW1699

Este producto cumple con la Directiva de Bajo Voltaje (73/23/CEE), Directivas EMC (89/336/CEE, 92/31/CEE) y Directiva de Marcación CE (93/68/CEE).

ADVERTENCIA: PARA EVITAR INCENDIOS Y DESCARGAS ELÉCTRICAS, NO EXPONGA ESTE APARATO A LA LLUVIA NI A LA HUMEDAD.

CONSULTE AL REPRESENTANTE DE VENTAS DE LA COMPAÑÍA. "UTILICE SOLAMENTE EL CABLE DE ALIMENTACIÓN APROBADO Y SEGURO". CON ESTE EQUIPO DEBERÁ UTILIZARSE UN CABLE DE ALIMENTACIÓN CERTIFICADO. PARA UNA CORRIENTE NOMINAL DE HASTA 6 A DEBERÁ UTILIZARSE UNO CUYO TIPO NO SEA MÁS LIGERO QUE EL H05VV-F3G DE 0,75 mm² O EL H05VVH2-F3G DE 0,75 mm².

La generación de ruido acústico es inferior a 70 dB. (ISO 7779/DIN45635)

El interruptor de alimentación en espera/encendido está conectado en secundario y, por lo tanto, no desconecta la unidad de la toma de alimentación cuando está en la posición de alimentación en espera.

Please read through these operating instructions so you will know how to operate your model properly. After you have finished reading the instructions, put them away in a safe place for future reference.

- This player is not suitable for commercial use.

Before using

Thank you for buying this Pioneer product. Please read through these operating instructions so you will know how to operate your model properly. After you have finished reading the instructions, put them away in a safe place for future reference.

Check Accessories

Audio cord	1
Video cord	1
AC cord	2

(European model)



(UK model)

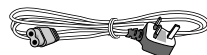

Remote control unit	1
Batteries (AA/R6P)	2
Laser barcode sheet	1
Operating Instructions	1

Inserting batteries into the remote control

While pressing the back cover, pull out in the direction indicated by the arrow and insert R6P size dry cell batteries.

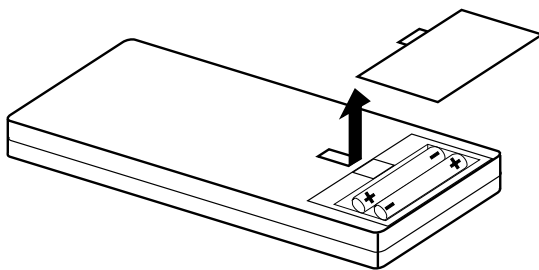

- Make sure to match the plus (+) and minus (-) polarity guides in the batteries with the marks inside the battery compartment.

Note

- Do not mix old and new batteries.
- Even batteries of the same type will differ in voltage. Do not mix different type of batteries together.
- When not using the remote control for a long period of time (over 1 month), remove the batteries to avoid possible damage from battery corrosion. If battery leakage occurs, wipe the battery liquid from the battery component, then insert new batteries.

Component Features and Functions

1. High-reliability, high-endurance player

This player features a high-performance brushless spindle motor, and the mechanical components have been sealed against heat and dust, giving this unit improved reliability.

2. PAL/NTSC dual playback

DVD discs in either the PAL format or the NTSC format can be played back. (See page 84)

3. Frame search function

When the frame search function is used, searching is possible in units smaller than when searching by chapter and time, and any point can be found. (See page 20) When frame segment playback is used, it is possible to play back from any point to any point in a video with still playback at the end. (See page 61, 62)

- The frame search function cannot be used with a multi PGC disc (time is not displayed on the TV screen) or with a Video CD, etc. Frame segment playback is possible with the DVD barcode, RS-232C control and a Barcode/Command stack.

4. High-speed search

With a 1.3X reading speed and improved memory cache and search algorithm, the search speed has been increased. (See page 19, 20)

5. Enhanced special playback

This player enables the DVD and Video CD playback speed to be changed in several ways. Slow forward and reverse playback, scan playback and frame forward/reverse can be freely selected. (See page 18, 20, 21)

- To perform reverse slow playback, select Frame from the REV STEP/REV PLAY page of the ADV.SETUP MENU. Slow playback is only possible in the forward direction with a Video CD.

6. Mouse control

Instead of the remote control unit, a PS/2* pointing device can be used to control the player if desired. This allows selecting specific locations by the point-and-click method. (See page 49)

* PS/2 is a registered trademark of IBM corporation.

7. Weekly timer/ power on start function

The times for power on/off and for video playback of a disc can be set for each day within one week or within one day. Combined with the barcode/command stack, program playback is also possible. This player is limited to a maximum of 24 settings at one time.

(See page 50, 58)

8. Barcode/Command stack

This player, when segment commands and barcodes that control are input in advance, enables images to be switched and played back one after the other. This is very convenient when used in demonstrations, presentations, etc. Furthermore, the RS-232C connection allows uploading/downloading of the set content.

(See page 59)

- Uploading/downloading can be easily performed when dedicated applications are being used.

9. Interface with external signals (RS-232C, external option switch)

The device is fitted with an RS-232C connection so that commands can be given to support DVD, Video CD and CD. The control protocol is, for the most part, compatible with that of LD (Laser Disc) equipment, and LD signals can also be easily transferred.

Other than the RS-232C interface connector, a terminal for the external option switch is provided. By simply connecting a switch to this terminal, operation is possible for DVD-VIDEO menu selection and barcode/command stack calls as well as operation of the remote control unit.

- Consult the User's Manual for detailed information regarding this terminal and RS-232C control commands. (See your dealer for more information about the User's manual.)

10. Video blackboard function

Graphics and characters recorded in advance at desired positions on the DVD picture screen will appear during playback.

This function enables demonstrations and presentations to be more effectively performed. (See page 76)

11. Video Text Retrieval

With this function, you can use the mouse to click on buttons shown on-screen during playback for display of indications of the text file corresponding to the selected button. This is possible only with Video Text Retrieval compatible discs. (See page 82)

12. External Synchronizing Function

This terminal allows output of video signals linked to an external sync signal. (See page 82)

Basic Operations

Remote Control Operations	16
Playing DVDs, CDs, and Video CDs.	16
Chapter (Track) skip forward/skip back	18
Stopping playback and switching power off	18
Searching for a desired scene (SEARCH)	19
Still frame/Frame advance/Frame reverse	20
Slow motion Play	21
Repeat Play	21
Program Play	22
Viewing disc information	24
Switching the Angle of the Image (Multi-Angle)	26
Switching the Subtitles during Playback	26
Switching the Audio during Playback	27
Switching the stereo/left/right Audio	27
Index of the Graphical User Interface (GUI)	28
Operating the Initial Setup Menu	29
Selecting the aspect ratio	29
Changing visual setting	31
Setting the Language	33
Setting viewing and listening restrictions (Parental Lock)	37
Making the ordinary settings	39
Setting the Digital Output	40
Setting to Optimize the Audio Quality	42
Returning to the default settings at the time of shipment.....	44
Language code list	44

Advanced Operations

Advanced Feature Operations	45
ADV. SETUP MENU settings	47
Player control using a mouse	49
Weekly timer function operation/display	50
Power on start function	57
Barcode/Command stack function	59
Barcode/Command stack setting	60
Grouping some Barcode/Command Stacks	67
Using a Barcode/Command Stacks	74
Character Input/Output drawing (DVD video blackboard)	76
Grouping video blackboards	80
Video text retrieval	82
External synchronizing function	82
How to display total hours played and power on time	83
Connecting the player	83
Using a Laser Barcode Scanner (Sold Separately)	89
Troubleshooting	90
Terms	91
Specifications	92

Precaution regarding use

Installation

- Install the player in a level and stable location. Do not use in shaky, unstable locations, or locations exposed to much vibration.
- Do not impair the player's cooling functions. Avoid placing on long-pile carpets, etc.. Also do not wrap or cover with towels or cloths when in use. Such coverings can impede the player's cooling function and result in internal damage.
- Do not place objects on top of the player.
- Install in a location which is not exposed to heat sources. Avoid installing the player above an amplifier or other heat-emitting component. If installing the player in a component rack, select a rack with good ventilation, located well below the amplifier.
- If the player is installed in a rack, care must be taken to avoid internal temperature buildup. Position it so that the ventilation openings in the top and bottom of the player are not obstructed. As a rule, install so that there is no heat from below and leave a gap of 10 cm or more at the left and right and above so that air can flow around the device by natural convection at a room temperature of 35°C or less. If installation is necessary in any other circumstances, ensure that the air temperature at a point 5 cm above the center of the player in a sufficiently warmed up state is no higher than 35°C. When necessary, use forced air cooling.
- When multiple players are connected in parallel, a high surge current will be impressed on the units when external power is first turned on. Please consult your Pioneer dealer regarding ratings for the power switch to be used.
- Do not install the player in a closed rack. An internal temperature builds up and results in internal damage.

Operating Environment

Operating environment temperature and humidity:
+5°C - +35°C ; less than 85% RH (cooling vents not blocked)

■ Do Not Install in the Following Locations:

- Locations exposed to direct sunlight or strong artificial light
- Locations exposed to dust or smoke
- Locations subject to vibration
- Locations subject to strong electro-magnetic fields.
- Near sources of heat.
- Locations exposed to high levels of electronic noise
- Locations subject to electrostatic noise
- Locations exposed to high humidity, or poorly ventilated locations
- A closed rack

Moving the Player

When transporting this player to a new location, be sure to use the packaging provided and avoid subjecting the player to vibration, shock, or dropping. During transport, protect the player from exposure to heat or water.

Before packaging the player, remove any disc loaded, since moving the player with a loaded disc may cause damage to the disc or player's internal parts.

Special Precautions!

Never attempt to move the player while a disc is playing. Discs rotate at very high speeds during play, and lifting or moving the player at such times could cause damage to the disc. Also, subjecting the player to strong impact or vibration when a disc is loaded may cause damage to disc or player. Be sure the player is stopped and no disc is loaded before moving the player. Also be sure that no disc is loaded when lifting the player.

This component is built using precision optical parts. Be sure to take care to control temperature and dust inside the room where this player is installed.

Copyright

- Unauthorized public preference, broadcasting, or copying is a violation of applicable laws.
- This product incorporates copyright protection technology that is protected by method claims of certain U.S. patents and other intellectual property rights owned by Macrovision Corporation and other rights owners. Use of this copyright protection technology must be authorized by Macrovision Corporation, and is intended for home and other limited viewing uses only unless otherwise authorized by Macrovision Corporation. Reverse engineering or disassembly is prohibited.

Handling the discs

■ Handling

- Never play clacked, scratched or warped disc. This may damage the player or cause it to malfunction.
- Do not damage or dirty the signal surface of the disc.
- Do not affix paper and seals to the disc.
- Too much glue will cause a malfunction. Many rental discs, particularly, have labels affixed to them, and use the disc after confirming that there is no glue.

■ Stacking

- Store the discs carefully. If you store discs at an angle, or stacked on top of each other, discs may become warped even when in their jackets.
- Read the operating instructions included in discs.

■ Cleaning

- **Fingerprints or other dirt on the disc may affect sound and picture quality. To remove dirt or finger prints, wipe gently from the inside toward the outer edges. (Do not wipe in a circular direction.)**
- Discs must not be cleaned with record cleaning sprays, or static prevention sprays, etc. Also do not use volatile liquids such as benzine, or thinner, etc.
- To clean your discs, use a soft clean cloth to wipe them. If necessary, moisten a soft cloth with diluted neutral detergent to remove heavy dirt or fingerprints.

■ Discs with special shapes

Discs with special shapes (heart shaped discs, hexagonal discs, etc.) cannot be played on this set.

Attempting to do so may damage the set. Do not use such discs.

Lens cleaning

The player's pickup lens should not become dirty in normal use but if for some reason it should malfunction due to soiling, contact your nearest PIONEER authorized service centre. Lens cleaners are commercially available but special care should be exercised in their use since some may cause damage to the lens.

Condensation

Moisture will form in the operating section of the player if the player is brought from cool surroundings into a warm room or if the temperature of the room rises suddenly. When this happens, player's performance will be impaired.

To prevent this, let the player stand in its new surroundings for about an hour before switching it on, or make sure that the room temperature rises gradually.

Condensation may also form during the summer if the player is exposed to the breeze from an air conditioner. In such cases, change the location of the player.

Précautions à prendre concernant l'utilisation

Installation

- Installez le lecteur sur une surface horizontale et stable. Ne le placez pas sur une surface branlante, instable ou dans un endroit exposé à trop de vibrations.
- Ne gênez pas le refroidissement du lecteur. Évitez de le placer sur une moquette épaisse, etc. Ne l'enveloppez ni le couvrez de serviettes ou de vêtements pendant qu'il fonctionne. Cela pourrait nuire aux fonctions de refroidissement du lecteur et l'endommager intérieurement.
- Ne placez pas d'objet sur le lecteur.
- Installez-le dans un endroit qui n'est pas exposé à une source de chaleur. Évitez de l'installer au-dessus d'un amplificateur ou d'un autre appareil générant de la chaleur. Si vous l'installez dans un meuble, sélectionnez un emplacement ayant une bonne ventilation, situé bien au-dessous de l'amplificateur.
- Si le lecteur est installé dans un meuble, il faut prendre des précautions pour éviter une montée de la température interne. Positionnez-le de sorte que les orifices de ventilation sur les panneaux inférieur et supérieur du lecteur ne soient pas obstrués. En règle générale, installez le lecteur de sorte qu'il n'y ait pas de chaleur depuis le bas et laissez un espace d'au moins 10 cm sur la gauche, la droite et au-dessus afin que l'air puisse circuler autour de l'appareil par convection naturelle à une température ambiante de 35 °C ou moins. S'il est nécessaire d'effectuer l'installation dans d'autres conditions, assurez-vous que la température à un point se trouvant 5 cm au-dessus du centre du lecteur, lorsque celui-ci est en état de préchauffage suffisant, ne dépasse pas 35 °C. Si nécessaire, utilisez une ventilation forcée.
- Lorsque plusieurs lecteurs sont raccordés en parallèle, un courant de pointe élevé sera sorti aux appareils lorsque la tension externe est tout d'abord appliquée. Consultez votre distributeur Pioneer pour les caractéristiques nominales de l'interrupteur d'alimentation à utiliser.
- N'installez pas le lecteur dans un meuble fermé. Cela provoquerait des dommages internes lorsque la température interne s'élève.

Ambiance de fonctionnement

Température et humidité de l'ambiance de fonctionnement : +5 °C - +35 °C ; moins de 85% d'humidité relative (orifices de refroidissement non obstrués)

■ N'effectuez pas l'installation dans les emplacements suivants :

- Endroits exposés aux rayons directs du soleil ou à une forte lumière artificielle
- Endroits exposés à de la poussière ou fumée
- Endroits soumis à des vibrations
- Endroits soumis à de forts champs électromagnétiques
- Près de sources de chaleur
- Endroits exposés à de hauts niveaux de parasites électroniques
- Endroits soumis à des parasites électrostatiques
- Endroits exposés à une forte humidité ou mal aérés
- Un meuble fermé

Déplacement du lecteur

Pour transporter le lecteur, utilisez toujours l'emballage fourni et évitez de soumettre le lecteur à des vibrations, des chocs ou de le laisser tomber. Pendant le transport, protégez le lecteur pour ne pas l'exposer à la chaleur ou à l'eau. Avant d'emballer le lecteur, retirez tout disque chargé car un déplacement du lecteur lorsqu'un disque est chargé peut endommager le disque ou les pièces internes du lecteur.

Précautions spéciales !

N'essayez jamais de déplacer le lecteur pendant qu'un disque est en cours de lecture. Les disques tournent à très grande vitesse pendant la lecture et vous pouvez endommager le disque si vous soulevez ou déplacez le lecteur à ce moment-là. Un choc important ou des vibrations pendant qu'un disque est chargé peuvent également endommager le disque ou le lecteur. Vérifiez toujours que le lecteur est arrêté et qu'aucun disque n'est chargé avant de déplacer le lecteur. Assurez-vous aussi qu'aucun disque n'est chargé avant de soulever le lecteur. Cet appareil incorpore des pièces optiques de précision. Contrôlez la température et la poussière à l'intérieur de la pièce où ce lecteur est installé. **www.liveline.be**

Droits d'auteur

- La présentation publique, la diffusion ou la copie non autorisées sont une violation des lois applicables.
- Ce produit incorpore une technologie à protection de droits d'auteur qui est protégée par des titres de méthode de certains brevets américains et autres droits de propriété intellectuelle détenus par Macrovision Corporation et d'autres ayant droits. L'utilisation de cette technologie à protection de droits d'auteur doit être autorisée par Macrovision Corporation et elle n'est destinée qu'à des utilisations privées et autres visionnements limités sauf autorisation de Macrovision Corporation. L'ingénierie à rebours ou le désassemblage est interdit.

Manipulation des disques

■ Manipulation

- N'utilisez jamais un disque fêlé, rayé ou déformé. Cela pourrait endommager le lecteur ou provoquer un fonctionnement défectueux.
- N'endommagez ni ne salissez la surface de signal du disque.
- N'apposez pas de papier et d'autocollant sur un disque.
- Trop de colle peut provoquer un fonctionnement défectueux. De nombreux disques de location, en particulier, portent des étiquettes n'utilisez ces disques qu'après avoir vérifié qu'il n'y a pas de colle.

■ Empilage

- Rangez les disques avec soin. Évitez que les disques ne demeurent inclinés ou ne soient empilés, ce qui peut les voiler, même lorsqu'ils sont dans leur coffret.
- Lisez les instructions d'utilisation fournies avec les disques.

■ Nettoyage

- **Les empreintes digitales et les taches que peut porter la surface du disque peuvent, selon leur importance, Pour enlever la saleté ou les traces de doigts, essuyez doucement de l'intérieur vers le bord extérieur. (N'essayez pas dans le sens circulaire).**
- N'utilisez aucun produit de nettoyage pour les microsilicons. Pareillement, ne tentez pas de nettoyer un disque avec de l'essence, du diluant pour peinture ou tout autre solvant volatil.
- Pour nettoyer un disque, essuyez-le au moyen d'un chiffon doux. Si le disque est très sale, humectez d'eau un chiffon et, après l'avoir bien essoré, éliminez les taches en procédant avec soin et sans frotter.

■ Disques de forme spéciale

Les disques de forme spéciale (disques en forme de cœur, disques hexagonaux, etc.) ne peuvent pas être lus sur cet appareil. N'essayez pas d'utiliser de tels disques car ils pourraient endommager l'appareil.

Nettoyage de la lentille

En principe, il n'y a aucune raison pour que l'optique du capteur se salisse; toutefois, si cela devait se produire et entraîner une anomalie de fonctionnement, consultez le centre d'entretien PIONEER. Des produits et des dispositifs de nettoyage de l'optique sont vendus dans le commerce, mais nous ne saurions trop vous conseiller d'être prudent dans leur usage car certains peuvent faire plus de mal que de bien.

Condensation

La vapeur d'eau peut se condenser à l'intérieur des parties nobles de l'appareil si vous le transportez d'une pièce froide vers une pièce chaude, ou encore si la température de la pièce dans laquelle il se trouve augmente rapidement. La condensation de l'humidité a pour effet d'altérer les performances de l'appareil.

Pour l'éviter, conservez l'appareil dans son nouvel environnement pendant au moins une heure avant de le mettre sous tension, ou bien veillez à ce que la température n'augmente que progressivement. L'été, l'humidité peut également se condenser si l'appareil est placé dans le courant d'air frais d'un climatiseur. En ce cas, changez la place de l'appareil.

Vorsichtshinweise zum Gebrauch

Aufstellung

- Den Player auf einer waagerechten, stabilen Unterlage aufstellen. Den Player nicht auf einer schrägen oder instabilen Unterlage oder an einem Ort aufstellen, der starken mechanischen Schwingungen ausgesetzt ist.
- Die Kühlvorrichtungen des Players nicht behindern, z.B. durch Aufstellung auf einem langfasrigen Teppich usw. Den Player beim Betrieb nicht mit einem Handtuch oder einer Decke umwickeln oder abdecken. Durch eine derartige Abdeckung kann die Wärmeabfuhr blockiert und eine Beschädigung des Players verursacht werden.
- Keinerlei Gegenstände auf den Player stellen.
- Den Player an einem Ort aufstellen, an dem er keinen Wärmequellen ausgesetzt ist. Eine Aufstellung des Players auf einem Verstärker oder anderen Wärme abgebenden Gerätes vermeiden. Bei Einbau des Players in einem HiFi-Schrank ein Regal mit guter Belüftung und möglichst weit unterhalb des Verstärkers auswählen.
- Wenn der Player in einem HiFi-Schrank aufgestellt wird, muss für ausreichende Wärmeabfuhr gesorgt werden. Den Player so platzieren, dass die Entlüftungsschlitze an der Ober- und Unterseite des Gerätes nicht blockiert sind. Dabei darf keine Wärme von oben auf den Player abgestrahlt werden, und es muss ein Freiraum von mindestens 10 cm über und an beiden Seiten des Players eingehalten werden, damit bei einer Zimmertemperatur von weniger als 35 °C ein natürlicher Luftkonvektionsstrom im Umfeld des Gerätes gewährleistet ist. Falls eine Aufstellung unter anderen Bedingungen unvermeidbar ist, sicherstellen, dass die Lufttemperatur in einem Abstand von 5 cm über der Mitte des betriebswarmen Players 35 °C nicht überschreitet. Gegebenenfalls muss eine Zwangskühlung vorgesehen werden.
- Wenn mehrere Player parallel angeschlossen sind, werden die Geräte beim erstmaligen Einschalten der externen Stromversorgung einem hohen Stromstoß ausgesetzt. Bitte den Pioneer-Fachhändler zu den minimalen Kennwerten des zu verwendenden Stromschalters konsultieren.
- Den Player nicht in einem durch Türen verschlossenen HiFi-Schrank aufstellen. Anderenfalls kann es zu einem Wärmestau und somit zu einer Beschädigung von Bauteilen im Geräteinneren kommen.

Betriebsumgebung

Betriebstemperatur und -luftfeuchtigkeit:
5 °C bis 35 °C, weniger als 85 % rel. Feuchte (Entlüftungsschlitze dürfen nicht blockiert werden.)

■ Eine Aufstellung an den folgenden Orten vermeiden:

- Orte, die direkter Sonneneinstrahlung oder starkem Kunstlicht ausgesetzt sind
- Orte, die einer hohen Staubkonzentration oder Rauch ausgesetzt sind
- Orte, an denen mechanische Schwingungen auftreten
- Orte, die starken elektromagnetischen Feldern ausgesetzt sind
- In der Nähe von Wärmequellen
- Orte, die starken elektronischen Rauscheinstrahlungen ausgesetzt sind
- Orte, an denen elektrostatisches Rauschen auftritt
- Orte, an denen eine hohe Luftfeuchtigkeit herrscht, sowie unzureichend belüftete Orte
- In einem geschlossenen HiFi-Schrank

Transport des Players

Den Player zum Transport an einen anderen Ort unbedingt wieder in seinem Original-Verpackungskarton verpacken. Den Player vor starken Erschütterungen und Stößen schützen und beim Transport nicht fallen lassen. Während des Transports den Player vor Hitze und Wasser schützen. Vor dem Verpacken des Players darauf achten, eine evtl. eingelegte Disc zu entfernen. Wird der Player mit eingelegter Disc transportiert, kann dies eine Beschädigung von Disc und Bauteilen im Geräteinneren verursachen.

Zur besonderen Beachtung!

Den Player auf keinen Fall bewegen, während eine Disc abgespielt wird. Da die Disc mit hoher Drehzahl im Geräteinneren rotiert, kann sie durch Anheben oder Transportieren des Players an einen anderen Ort beschädigt werden. Wird der Player starken Stößen oder Erschütterungen ausgesetzt, während eine Disc eingelegt ist, können Disc und Player dadurch beschädigt werden. Vor einem Transport des Players sicherstellen, dass der Player auf Stopp geschaltet und keine Disc eingelegt ist. Auch vor einem Anheben des Players nachprüfen, dass keine Disc eingelegt ist. Bei diesem Gerät finden optische Bauteile Anwendung, die mit höchster Präzision gefertigt wurden. Daher unbedingt darauf achten, dass die Umgebungstemperatur den zulässigen Bereich nicht überschreitet und keine hohe Staubkonzentration am Aufstellungsort vorliegt.

Hinweise zum Urheberrecht

- Eine öffentliche Verbreitung oder Übertragung sowie das Kopieren von urheberrechtlich geschütztem Material ohne schriftliche Genehmigung des Inhabers der Urheberrechte ist strafbar.
- Dieses Produkt ist mit einer Urheberrechtlich-Vorrichtung ausgestattet, deren Technologie durch US-Patente und geistige Eigentumsrechte im Besitz von Macrovision Corporation und anderen Inhabern von Urheberrechten geschützt ist. Der Gebrauch dieser Urheberrechtlich-Vorrichtung muss durch Macrovision Corporation genehmigt werden und ist ausschließlich für die private Nutzung vorgesehen, sofern dem Benutzer keine weitergehende Genehmigung von Macrovision Corporation erteilt worden ist. Untersuchungen dieses Gerätes zum Zweck eines unbefugten Nachbaus sowie Zerlegen sind untersagt.

Hinweise zum Umgang mit Discs

■ Handhabung

- Auf keinen Fall eine gesprungene, zerkratzte oder verwellte Disc in diesem Player abspielen. Derartige Discs können den Player beschädigen oder Funktionsstörungen verursachen.
- Die Abspielfläche der Disc nicht beschädigen oder Schmutz aussetzen.
- Keine Etiketten oder Aufkleber an der Disc befestigen.
- Bei Verwendung von Leih-Discs, an denen Aufkleber mit zuviel Klebstoff angebracht worden sind, können Funktionsstörungen auftreten. Vor dem Abspielen einer derartigen Disc sicherstellen, dass kein Klebstoff unterhalb des Aufklebers ausgetreten ist.

■ Aufbewahrung

- Beim Aufbewahren der Discs vorsichtig vorgehen. Wenn die Discs schräg positioniert sind oder gestapelt werden, können sich die Discs verziehen, selbst wenn sie sich in der Hülle befinden.
- Die Anweisungen in der Begleitliteratur von Discs befolgen.

■ Reinigung

- **Fingerabdrücke und andere Verschmutzung auf der Disc kann die Bild- und Tonqualität nachteilig beeinflussen. Zum Entfernen von Schmutzflecken und Fingerabdrücken die Disc mit einem weichen, trockenen Tuch sanft abreiben, das von der Mitte gerade nach außen geführt wird. (Das Tuch nicht in einer kreisförmigen Bewegung über die Oberfläche der Disc führen.)**
- Verwenden Sie keine Plattenreinigungs-Sprays oder Antistatik-Mittel an diesen Discs. Achten auch darauf, daß flüchtige Chemikalien, wie Benzol, Verdüner usw., nicht auf die Disc gelangen.
- Zur Reinigung einen weichen, trockenen Lappen verwenden. Wenn erforderlich, kann der Lappen leicht mit neutralem Haushaltsreiniger angefeuchtet werden, um starke Verschmutzung zu entfernen.

■ Nicht normgerechte Discs

Mit diesem Player können keine anderen als kreisförmige Discs (herzförmige, achteckige Discs usw.) abgespielt werden. Wird versucht, eine nicht kreisförmige Disc abzuspielen, kann der Player dadurch beschädigt werden. Ausschließlich normgerechte Discs verwenden.

Reinigen der Abtasterlinse

Eine Reinigung der Pickup-Linse des Geräts dürfte bei normaler Verwendung nicht erforderlich werden. Sollte aber durch Verschmutzung eine Funktionsstörung auftreten, ziehen Sie eine PIO-NEER-Kundendienstwerkstatt zu Rate. Linsen-Reinigungsmittel sind zwar im Fachhandel erhältlich, doch kann eine unsachgemäße Anwendung eine Beschädigung der Linse zur Folge haben.

Kondensatbildung

Wenn das Gerät von einem kalten Ort in einen warmen Raum gebracht wird, oder wenn die Temperatur im Raum innerhalb kurzer Zeit stark ansteigt, kann sich im Betriebsbereich des CD-Spielers Feuchtigkeit abscheiden. In diesem Fall ist ein einwandfreier Betrieb unter Umständen nicht mehr möglich.

Um dies zu verhindern, muß das Gerät in der neuen Umgebung vor dem Einschalten etwa eine Stunde stehengelassen werden, oder darauf achten, daß die Raumtemperatur nach und nach erhöht wird. Kondensatbildung kann auch im Sommer auftreten, wenn das Gerät der kühlenden Klimaanlage ausgesetzt ist. In diesem Fall muß ein anderer Aufstellort für das Gerät gewählt werden.

Precauzioni riguardo l'uso

Installazione

- Installare il lettore in una posizione orizzontale e stabile. Non usarlo in posizioni traballanti e instabili o in posizioni soggette a molta vibrazione.
- Non danneggiare le funzioni di raffreddamento del lettore. Evitare di collocarlo su un'alta pila di tappeti, ecc. Inoltre non avvolgere o coprire con asciugamani o panni durante l'uso. Tali coperture possono ostacolare le funzioni di raffreddamento del lettore e provocare danni interni.
- Non mettere oggetti sopra al lettore.
- Installare in una posizione che non è esposta a fonti di calore. Evitare di installare il lettore sopra ad un amplificatore o un altro componente che emette calore. Se si installa il lettore in uno scaffale per componenti, selezionare uno scaffale con buona ventilazione e collocarlo molto sotto all'amplificatore.
- Se il lettore viene installato in uno scaffale, prestare attenzione al fine di evitare l'aumento della temperatura interna. Posizionarlo in modo che le aperture di ventilazione sulla parte superiore e sul fondo del lettore non siano ostruite. Come regola, installare in modo che non ci sia calore da sotto e lasciare una distanza di 10 cm o più a sinistra e a destra e sopra perché l'aria possa circolare intorno al dispositivo per convezione naturale ad una temperatura ambiente di 35°C o meno. Se l'installazione è necessaria in qualsiasi altra circostanza, assicurarsi che la temperatura dell'aria ad un punto pari a 5 cm sopra al centro del lettore in una condizione di sufficiente riscaldamento non sia superiore a 35°C. Quando è necessario, usare il raffreddamento forzato dell'aria.
- Quando più lettori sono collegati in parallelo, una elevata sovraccorrente momentanea viene applicata alle unità quando si attiva l'alimentazione esterna la prima volta. Consultare il rivenditore Pioneer riguardo i dati nominali per l'interruttore di alimentazione da usarsi.
- Non installare il lettore in uno scaffale chiuso. La temperatura interna aumenta e provoca danni interni.

Ambiente operativo

Temperatura e umidità dell'ambiente operativo:
+5°C-+35°C; inferiore all'85% di umidità relativa (aperture di raffreddamento non bloccate)

■ Non installare nei seguenti luoghi:

- Luoghi esposti alla luce diretta del sole o a forte luce artificiale
- Luoghi esposti alla polvere o al fumo
- Luoghi soggetti a vibrazione
- Luoghi soggetti a forti campi elettromagnetici
- Vicino a fonti di calore
- Luoghi esposti ad alti livelli di rumore elettronico
- Luoghi soggetti al rumore elettrostatico
- Luoghi esposti ad elevata umidità o luoghi scarsamente ventilati
- Uno scaffale chiuso

Spostamento del lettore

Quando si trasporta il lettore in una posizione nuova, assicurarsi di usare l'imballaggio in dotazione ed evitare di sottoporre il lettore a vibrazioni, urti o cadute. Durante il trasporto, proteggere il lettore dall'esposizione al calore o all'acqua.

Prima di imballare il lettore, togliere qualsiasi disco caricato, poiché spostando il lettore con un disco caricato si possono causare danni al disco o alle parti interne del lettore.

Precauzioni speciali!

Non tentare mai di spostare il lettore mentre un disco è in corso di lettura. I dischi ruotano a velocità molto alta durante la lettura e se si solleva o si sposta il lettore in quel momento si possono causare danni al disco. Inoltre, se si sottopone il lettore a forti urti o vibrazioni quando un disco è caricato si possono causare danni al disco o al lettore.

Assicurarsi che il lettore sia in modo di arresto e nessun disco sia caricato prima di spostare il lettore. Assicurarsi anche che nessun disco sia caricato quando si solleva il lettore.

Questo componente è costruito usando parti ottiche di precisione. Assicurarsi di fare attenzione a controllare la temperatura e la polvere all'interno della stanza in cui il lettore viene installato.

www.tiveline.be

Diritti d'autore

- La trasmissione o la copiatura non autorizzata di materiale pubblico di propria preferenza è una violazione delle leggi applicabili.
- Questo prodotto incorpora la tecnologia di protezione dei diritti d'autore che è protetta dai reclami tecnici di certi brevetti statunitensi e altri diritti di proprietà intellettuale in possesso della Macrovision Corporation e altri possessori dei diritti. L'uso di questa tecnologia di protezione dei diritti d'autore deve essere autorizzata dalla Macrovision Corporation ed è destinata all'uso domestico e di altre visioni limitate salvo autorizzazione contraria della Macrovision Corporation. È vietato eseguire le operazioni inverse e lo smontaggio.

Modo di maneggiare i dischi

■ Modo di maneggiare

- Non eseguire mai la lettura di un disco crepato, graffiato o deformato. Ciò può danneggiare il lettore o causare un malfunzionamento.
- Non danneggiare o sporcare la superficie del disco con i segnali.
- Non attaccare la carta e gli adesivi al disco.
- Troppa colla causa un malfunzionamento. Molti dischi a nastro, in particolare, hanno le etichette attaccate e quindi usare il disco dopo aver confermato che non ci sia la colla.

■ Accatamento

- Conservare i dischi con la dovuta cura. Se vengono conservati ad una certa angolazione o uno sopra l'altro, possono deformarsi perfino se contenuti nelle loro custodie.
- Leggere le istruzioni per l'uso incluse nei dischi.

■ Pulizia

- **Le impronte digitali e lo sporco sul disco possono influenzare la qualità del suono e delle immagini. Per togliere lo sporco o le impronte digitali, strofinare delicatamente dall'interno verso i bordi esterni. (Non strofinare in direzione circolare.)**

- I dischi non devono venire puliti con spray per la pulizia di dischi o antistatici. Non usare neppure liquidi volatili come benzina e diluente.
- Per pulire i propri dischi, usare un panno soffice e pulito. Se necessario, inumidirlo con detergente neutro diluito con acqua e togliere sporco tenace.

■ Dischi con forme speciali

I dischi con forme speciali (dischi a forma di cuore, dischi esagonali, ecc.) non possono essere letti con questo apparecchio.

Se si tenta di leggerli si può danneggiare l'apparecchio. Non usare tali dischi.

Pulizia della lente

La lente della testina di lettura del lettore non dovrebbe sporcarsi, ma se per qualche ragione non dovesse funzionare bene a causa di sporco accumulatosi su di essa, entrare in contatto col più vicino centro assistenza PIONEER. I pulitori per lenti sono in vendita, ma devono venire usati con particolare cura, dato che possono danneggiare la lente.

Condensa

Se il lettore viene portato improvvisamente da una stanza ad una fredda o se la temperatura ambiente sale velocemente, al suo interno si possono formare gocce di condensa. Se ciò accade, il lettore non può funzionare bene.

Per evitare che ciò accada, lasciare che il lettore riposi per circa un'ora prima di tentare di usarlo o far salire la temperatura ambiente in modo graduale.

La condensa si può formare anche se durante l'estate il lettore viene esposto ad aria fresca prodotta da un climatizzatore. In tali casi, spostare il lettore.

Precauciones relacionadas con la utilización

Instalación

- Instale el reproductor en un lugar nivelado y estable. No lo utilice en lugares poco firmes o inestables, ni en lugares expuestos a una vibración excesiva.
- No altere las funciones de refrigeración del reproductor. Evite colocarlo encima de alfombras de pelo largo, etc. Y no lo envuelva ni cubra con toallas o paños cuando lo utilice. Si lo cubre con tales cosas se anulará la función de refrigeración del reproductor y se producirán daños en su interior.
- No ponga objetos encima del reproductor.
- Instálelo en una posición que no esté expuesta a fuentes de calor. Evite instalar el reproductor encima de un amplificador u otro componente que emita calor. Si instala el reproductor en un estante de componentes, seleccione uno que esté bien ventilado y coloque el reproductor muy por debajo del amplificador.
- Si el reproductor se instala en un estante deberá evitarse la acumulación interna de calor. Póngalo de forma que las aberturas de ventilación de la parte superior e inferior del reproductor no estén tapadas. Por regla general, instálelo en un lugar a donde no llegue calor procedente de la parte inferior, y deje un espacio libre de 10 cm o más por los costados derecho e izquierdo y por la parte superior, para que el aire pueda circular alrededor del aparato mediante convección natural a una temperatura de la sala de 35°C o menos. Si resulta necesario hacer la instalación bajo otras circunstancias, asegúrese de que la temperatura del aire a un punto ubicado a 5 cm por encima del centro del reproductor, estando éste calentado lo suficiente, no sea superior a 35°C. Cuando sea necesario, utilice refrigeración de aire forzada.
- Cuando se conecten en paralelo múltiples reproductores, al conectar por primera vez la alimentación externa se aplicará a las unidades una corriente inicial alta. Consulte a su concesionario Pioneer en cuanto a los valores nominales para la conmutación de la alimentación que se vaya a utilizar.
- No instale el reproductor en un estante cerrado. El calor se acumula en el interior del aparato y se producen daños internos.

Ambiente de funcionamiento

Temperatura y humedad del ambiente de funcionamiento: +5°C-+35°C; menos del 85% de humedad relativa (orificios de ventilación sin bloquear)

■ No instale el aparato en los lugares siguientes:

- Lugares expuestos a la luz solar directa o a una luz artificial intensa.
- Lugares expuestos al polvo o al humo.
- Lugares expuestos a la vibración.
- Lugares expuestos a campos electromagnéticos intensos.
- Cerca de fuentes de calor.
- Lugares expuestos a altos niveles de ruido electrónico.
- Lugares expuestos a ruido electrostático.
- Lugares expuestos a una humedad alta o mal ventilados.
- Un estante cerrado.

Traslado del reproductor

Cuando transporte este reproductor a un nuevo lugar, asegúrese de utilizar el embalaje suministrado y evitar someterlo a vibraciones, golpes o caídas. Durante el transporte, proteja el reproductor contra el calor y el agua.

Antes de embalar el reproductor, retire el disco cargado, ya que mover el reproductor con un disco cargado puede estropear el disco y las partes internas del reproductor.

Precauciones especiales

Nunca intente trasladar el reproductor mientras se reproduce un disco. Los discos giran a alta velocidad durante la reproducción, y levantar o trasladar el aparato en esos casos puede estropear el disco. Además, someter el reproductor a un impacto o vibración fuerte estando un disco cargado puede causar daños en el disco o en el reproductor.

Asegúrese de que el reproductor esté parado y no haya ningún disco cargado antes de trasladar el reproductor. Asegúrese también de que no haya ningún disco cargado cuando levante el reproductor. Este componente ha sido construido utilizando piezas ópticas de precisión. Tenga cuidado para controlar la temperatura y el polvo en el interior de la sala donde esté instalado este reproductor.

Derechos de autor

- La emisión o la copia de programas sin autorización viola las leyes aplicables.
- Este producto incorpora tecnología de protección de los derechos de autor que a su vez está protegida por reclamaciones de métodos de ciertas patentes de los EE.UU. y otros derechos de propiedad intelectual propiedad de Macrovision Corporation y otros propietarios de derechos. La utilización de esta tecnología de protección de los derechos de autor debe contar con la autorización de Macrovision Corporation, y ha sido propuesta para ser utilizada en el hogar y en otros locales de visión limitada a menos que Macrovision Corporation autorice lo contrario. La inversión de ingeniería o el desmontaje están prohibidos.

Manejo de los discos

■ Manejo

- Nunca reproduzca discos rajados, rayados o deformados. Éstos pueden estropear el reproductor o hacer que funcione mal.
- No estropee ni ensucie la superficie de las señales de los discos.
- No ponga papel ni pegatinas en los discos.
- El exceso de cola causará problemas en el funcionamiento. Muchos discos de alquiler, en particular, tienen pegadas etiquetas, así que utilícelos después de confirmar que no tengan cola.

■ Instalación en pila

- Siga las instrucciones suministradas con los discos.
- Guarde los discos cuidadosamente. Si los guarda inclinados, o apilados uno encima de otro, los discos podrán deformarse aunque estén guardados en sus cajas.

■ Limpieza

- **Las huellas dactilares o la suciedad en los discos pueden afectar al sonido y a la calidad de la imagen. Para quitar la suciedad o las huellas dactilares, limpie suavemente desde el interior hacia el borde exterior. (No limpie los discos en sentido circular.)**
- Los discos no deben limpiarse con aerosoles de limpieza de discos de vinilo, con aerosoles que evitan la electricidad estática, etc. No utilice tampoco líquidos volátiles tales como bencina, diluyente, etc.
- Para limpiar sus discos, utilice un paño blando y limpio. De ser necesario, humedezca un paño blando en detergente neutro diluido para quitar la suciedad o las huellas dactilares difíciles de quitar.

■ Discos con formas especiales

Los discos con formas especiales (discos en forma de corazón, discos hexagonales, etc.) no pueden reproducirse en este aparato. Intentar reproducir estos discos puede estropear el aparato. No utilice tales discos.

Limpieza de la lente

La lente fonocaptora del reproductor no deberá ensuciarse con un uso normal, pero si por alguna razón funcionara mal porque está sucia, póngase en contacto con su centro de servicio PIONEER autorizado más cercano. En el comercio se encuentran a la venta limpiadores de lentes, pero deberá tenerse mucho cuidado al utilizarlos porque algunos podrían estropear la lente.

Condensación



La humedad puede formarse en la sección de funcionamiento del reproductor si éste se pasa de un lugar frío a otro caliente o si la temperatura de la sala aumenta repentinamente. Cuando pase esto, el rendimiento del reproductor se reducirá.

Para impedir esto, deje el reproductor en su nuevo ambiente durante una hora aproximadamente antes de conectar su alimentación, o asegúrese de que la temperatura de la habitación aumente gradualmente.

La condensación también puede formarse durante el verano si el reproductor se expone al aire frío de un acondicionador de aire. En tales casos, cambie la ubicación del reproductor.

Disc types compatible with this unit







- The marks shown below are found on disc labels or on disc jackets.
- This player can play all discs bearing the marks below without the need for an adaptor.
- This player can play discs recorded in either PAL or NTSC format. Use those discs which indicate "NTSC" or "PAL" on the jacket.

Types of playable discs and their marks	Diameter/Playable sides
DVD VIDEO 	DVD VIDEO
	12 cm /single sided 1 layer
	12 cm /double sided 1 layer
	12 cm /double sided 2 layer
VIDEO CD 	VIDEO CD
	12 cm /single sided
	VIDEO CD single
	8 cm /single sided
CD 	CD
	12 cm /single sided
	CD single
	8 cm /single sided

- Discs indicated below cannot be played on this player.
DVD audio, DVD-ROM, CD-ROM, DVD with regional number (see page 91) other than 2 or ALL.
- Do not use an 8cm adaptor.

DVD identification markings

The following markings are displayed on DVD discs and packaging to indicate the type of video or audio recorded on that disc and the functions that can be used:

Mark	Meaning
	The number of the audio
	The number of the subtitle language
	The number of angles
	The picture aspect ratios that can be selected
	The region number where playback is possible This player can play back discs which include region number "2" and discs on which "ALL" is inscribed.
	

Disc operation methods

The DVD operation method depends on the intention of the disc creator, and there are some discs that prohibit specific operations. For this reason, depending on the disc, the operation method differs and specific operations may not be possible. If a specific operation has been prohibited on the disc, the "Disc prohibition" mark is displayed on the screen of the player. Furthermore, with a disc that is capable of interactive operation in the menu and during playback, some operations such as repeat and program may not be possible. In this case, the "Prohibition due to the player" mark is displayed on the screen.

Disc prohibition mark



Prohibition due to the player mark



Names and Functions

■ Remote control unit

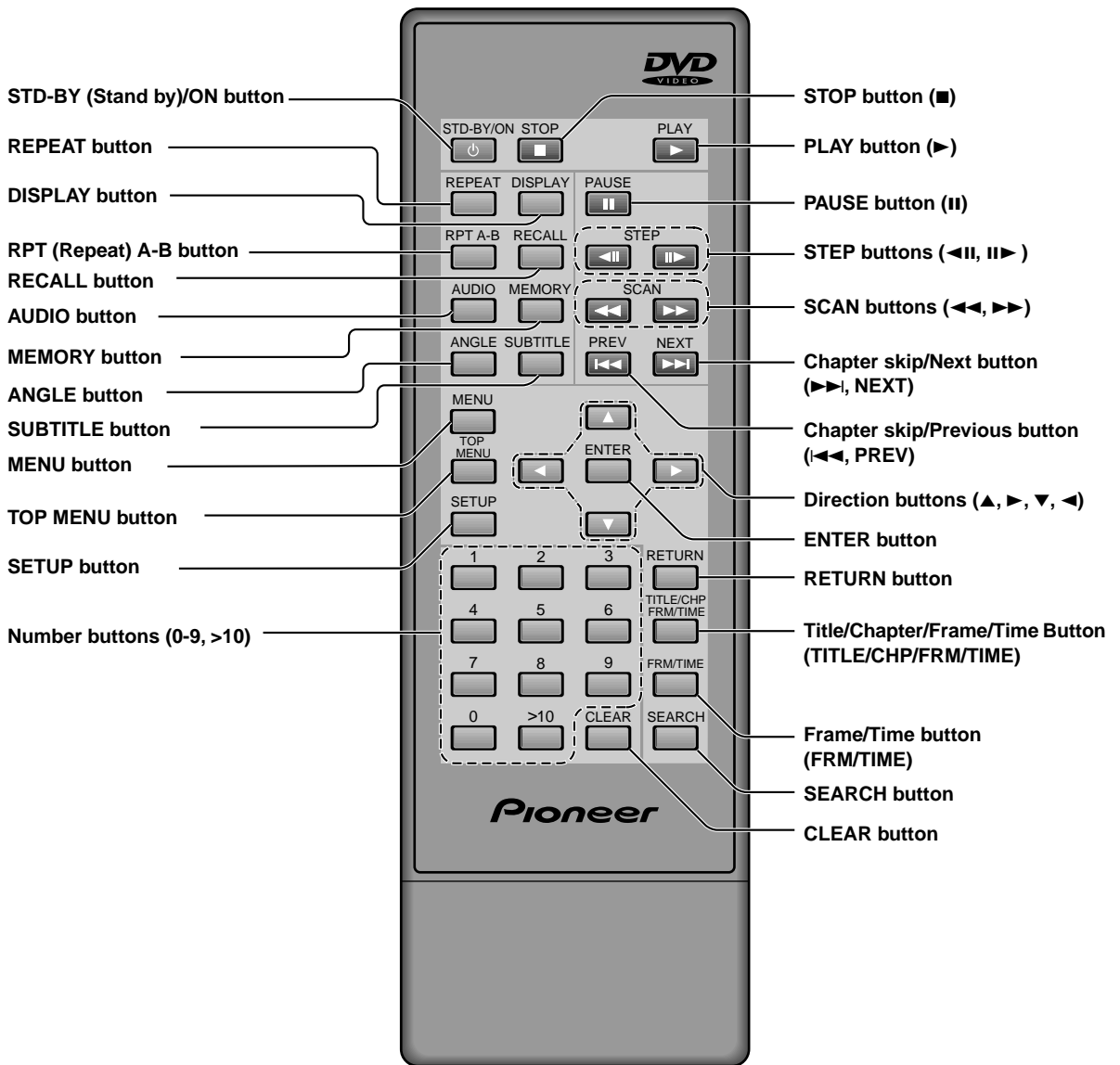

■ Front panel

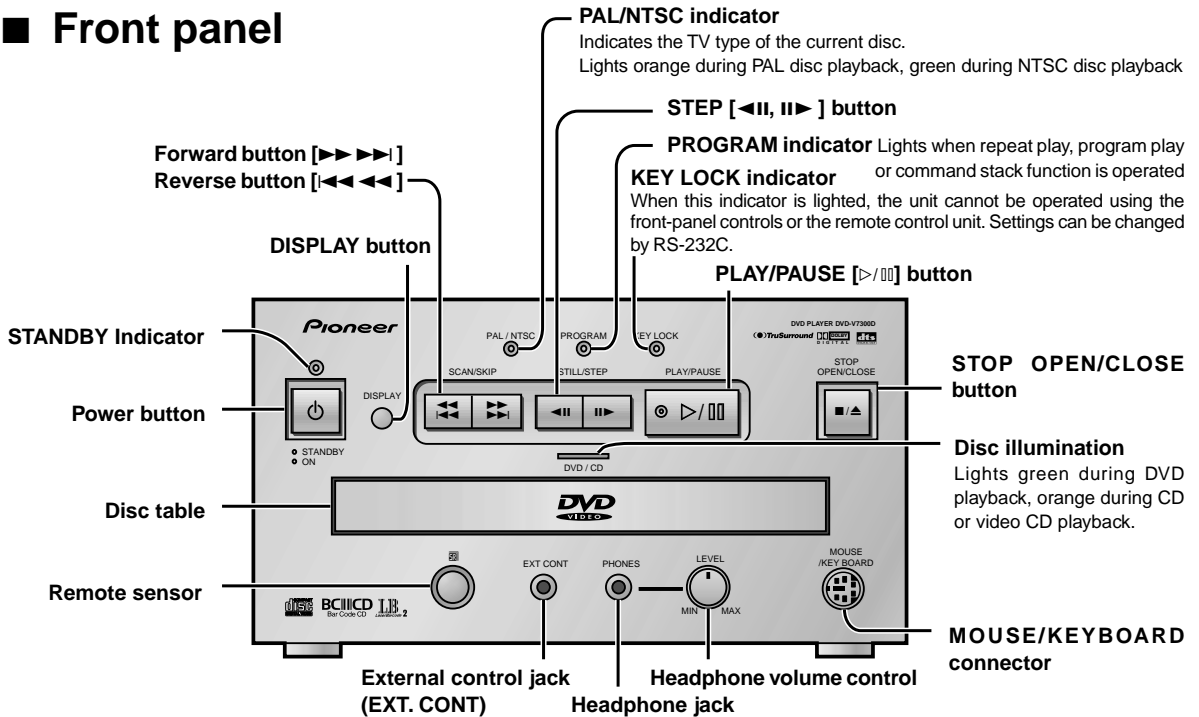

■ Rear panel

Your amp	Settings
Regular AV amp	Select [Dolby Digital ▶ PCM] from the SETUP MENU. (See page 40)
Dolby Digital compatible amp	Select [Dolby Digital] from the SETUP MENU. (See page 40)

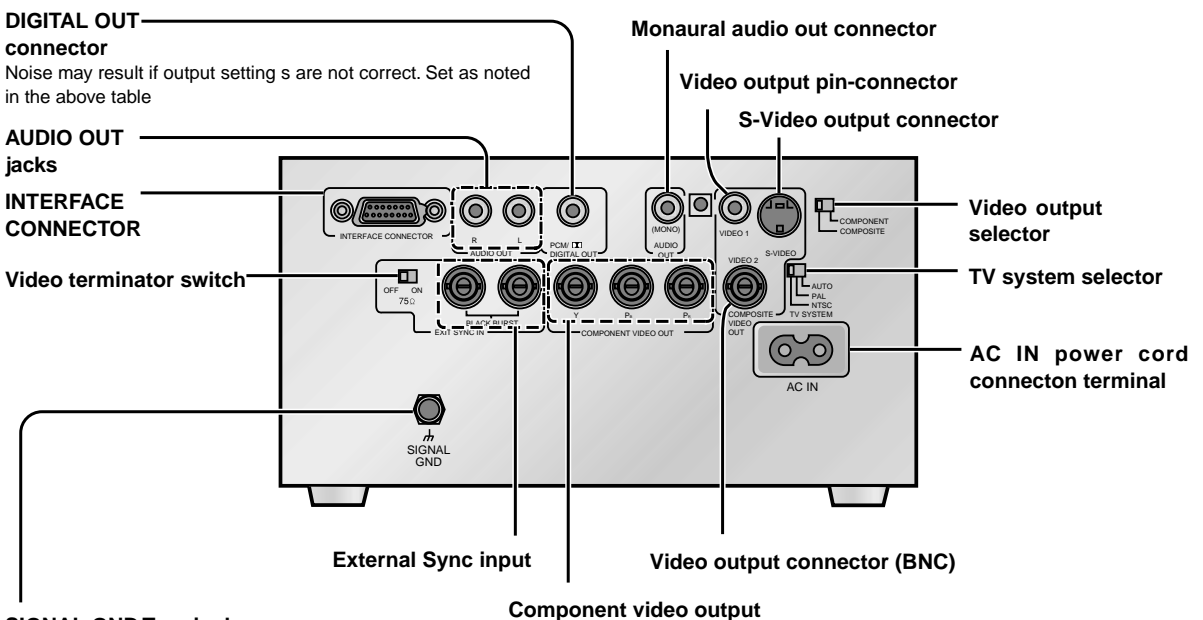

SIGNAL GND Terminal

This terminal is the SIGNAL GND terminal. Under certain environmental conditions which create a lot of noise, the mouse, etc., may fail to operate. The SIGNAL GND terminal is provided in such a case that the ground (GND) connections are linked among the devices used. It is not a safe grounding terminal.

Basic Operations

Remote Control Operations

Wireless Remote Operation

When operating the remote control, point it at the remote sensor located on the player's front panel. The remote control can be used up to 7 m from the player and within a 30° angle each side of the sensor.

- Exposing the remote sensor to direct sunlight or strong light may cause faulty operation.

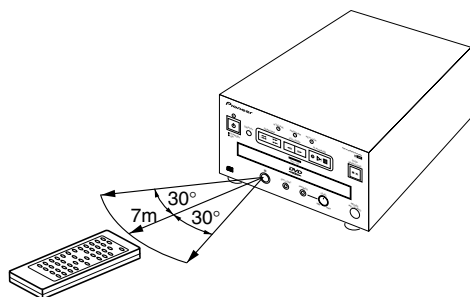

Wired Operation

Wired operation is possible with the separately sold remote control. Connect the remote control's supplied cord to the external control jack (EXT.CONT) on the player's front panel.

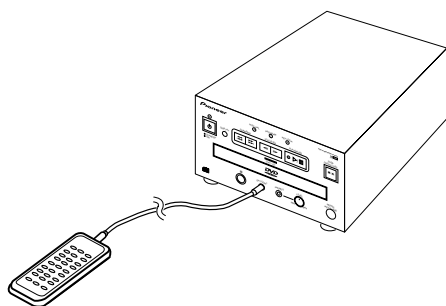

Playing DVDs, CDs, and Video CDs

DVD Video CD CD

1 Press  .

- The player's standby indicator changes from orange (stand by) to green (power on).

2 Press  .

- The disc table comes out.

3 Load a disc

- Load a disc with the label side facing up, using the disc table guide to align the disc.

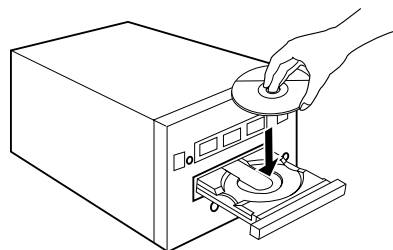

4 Press  .

- The disc table will close and playback will begin.
- Press  on the front of the player.
- Depending on the disc, a menu is displayed. If a menu is displayed, refer to the next page.

Note:

- DVD discs that do not have the matching region number that allows playback can not be played (refer to the "Terms" section on page 91). (This unit's region number is "2".)
- During operation, the following marks may appear on the TV screen.



: Appears when this player cannot perform the selected function.



: Appears when the disc cannot perform the selected function.

DVD Video CD**When the menu screen has been displayed**

DVDs and Video CDs, depending on the disc, feature selection menus.

This player lets you choose a desired title and music by selecting from a menu.

■During DVD playback

Press to select the selected item and press .

Example)

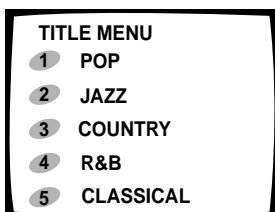
**■During Video CD playback**

Select with the number buttons.

• When the menu screen consists of two pages or more, press

to turn the pages.

Example)

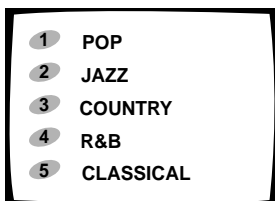
**■Turning the menu screen display off/on**

The way to display the menu screen differs depending on the disc, but menu screen is returned with DVD by pressing or during playback, and with Video CD, by pressing during PBC playback.

• Regarding operations on the menu screen, see the operation method accompanying the disc.

DVD Video CD**Returning to menu display during playback****■During DVD playback**

1 Press .

- Press again for a menu of title contents.
- Operate according to disc menus.

■During Video CD playback

1 Press .

Pressing during PBC playback will display the menu. Because the player's operation method and functions depend on the PBC, playback will differ according to the disc. For details, please refer to the disc's instruction manual.

Note

- When using a menu for Video CD playback; the repeat Play and Track/Time Search functions do not operate.
- Menu details differ depending on the disc. Play a disc by making menu selections using , and the number buttons.
- You can also play Video CDs without calling up a menu by pressing or a number button during STOP. For example, to start playback from track 1, press .

Chapter (Track) skip forward/skip back

DVD Video CD CD

Skipping forward to the next chapter (track)

Press ^{NEXT} .

- Press to skip forward to the next chapter (track).
-  on the front panel has the same function.

DVD Video CD CD

Skipping back to the previous chapter (track)



Press ^{PREV} .

- Press once to skip back to the start of the chapter (track) currently playing.
- Press again to skip back to the start of the previous chapter (track).
-  on the front panel has the same function.

DVD Video CD CD

Fast forward



Press and hold ^{SCAN} .

- Release ^{SCAN}  when you reach the desired location. Normal playback resumes.
-  on the front panel has the same function.
- When the "Scan" indicator on the screen changes from flashing to lit, fast forward will continue even if the button is released. When the desired location has been reached, press ^{SCAN} .

DVD Video CD CD

Fast reverse

Press and hold ^{SCAN} .

- Release ^{SCAN}  when you reach the desired location. Normal playback resumes.
-  on the front panel has the same function.
- When the "Scan" indicator on the screen changes from flashing to lit, fast rewind will continue even if the button is released. When the desired location has been reached, press ^{SCAN} .

Stopping playback and switching power off

DVD Video CD CD

1 Press ^{STOP} .

- On the front panel, press .
- Playback stops.

2 Press ^{STOP OPEN/CLUSE} .

- The disc table comes out.

3 Remove the disc.

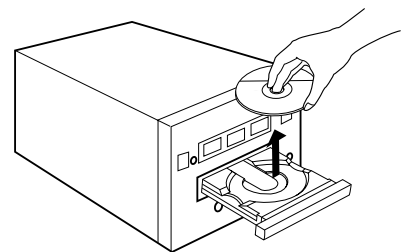

4 Press ^{STD-BY/ON} .

- The disc table goes back in, power switches OFF, and the STANDBY indicator changes from green to orange.

Searching for a desired scene (SEARCH)

DVD



Direct search with title numbers during playback

1 Press  during playback.

Title : 1

2 Selecting title numbers directly with the number buttons.

Title : 3

- When selecting title number 3, press .
- When selecting the title number 10, press  → .

3 Press .

- Pressing  is also available.

DVD

Direct search with the title numbers in the stop mode

If you press number buttons to select the title number in the stop mode, playback starts from beginning of the title you selected.

To select title number 3

Press .

To select title number 10

Press  →  → .

DVD Video CD CD

Searching by chapter/track number.

■ Using the TITLE/CHP FRM/TIME button

1 Press .

- DVD: Chapter numbers flash on screen when pressed twice.
- Video CD/CD: Track numbers flash on screen when pressed once.

2 Select chapter/track numbers directly with the number buttons.





Example 1: To select chapter/track number 31

Press  → .

Example 2: To select chapter/track number 117

Press  →  → .

3 Press .

- Playback of the selected chapter/track begins. .
- Pressing  or  is also available except .

DVD Video CD CD

Chapter/Track direct search

If you press number buttons to select the chapter/track number during playback, playback starts from beginning of the chapter/track you selected.

Example 1: To select chapter/track number 3

Press .

Example 2: To select chapter/track number 17.

Press  →  → .

Note

- If  appears when the numbers are entered, it is not possible to search.

Searching for a desired scene (SEARCH)

DVD Video CD

Searching by time/frame number (Time search/Frame search)

1 Press  to select the frame input mode or the time input mode.

- With Video CD, only time search is available.

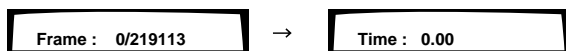





2 Select the desired time/frame number with the number buttons.

Example : To select 21 minutes 43 seconds





- With DVD, search cannot be performed for time/frame numbers which overlap titles.

3 Press .

- Pressing  or  is also available except .
- Playback starts from the selected elapsed play time.
- For frame searching, the still frame mode is set at the specified frame. (The accuracy in terms of frame may not be achieved exactly depending on the disc in use.)
Example)
Discs in which slideshow is recorded
movie DVDs (24 frame).
- Time Search/Frame Search are not possible with discs that do not provide playback time indications within a title when you press  (see page 25).

Point

- To cancel the Title, Chapter/Track/Time display that is flashing, press  twice.
- Using a menu to select is also possible for some titles. In this case, press  to display the menu screen and select while the display is being displayed.

Note

- With DVD, Time search may be impossible with certain titles. In this case, the  mark is displayed.
- When performing DVD or Video CD Time Search, playback may start from a slightly different time than that specified.
- On DVD discs, Time search is not possible during the stop mode.
- Search using the above operation is not possible during PBC playback of Video CDs.
- An error may occur when a frame search is conducted using several frames before or after the breaks in titles and chapters: this happens because of the way in which DVD are constructed.

Still frame/ Frame advance/ Frame reverse

DVD Video CD

Frame advance/Frame reverse (Playback the picture by 1 frame)

1 Press  .

-  : The picture will be advanced by one frame each time the button is pressed.

-  : The effect differs according to the following settings. (DVD only)

REV STEP/REV PLAY in ADV. SETUP (see page 48) is set to

Frame : The picture will be reversed by one frame each time the  button is pressed.

VOBU* : The picture will be reversed in VOBU each time the  button is pressed.



- The picture may not be advanced/reversed by 1 frame depending on such disc as movie DVD (24 frame) for example.
- If still images appear shaky when playing back DVD stop-motion frames, see page 31 and set the Still Picture to "Field". (Vertical resolution becomes half but eliminates burriness of the picture when in the picture.)
- If VOBU is selected, each time the  is pressed, playback is reversed by 0.4 seconds to 1 second.
- * **VOBU = Video Object Unit:**
In DVD-VIDEO, it is the smallest unit that forms a stream and, at the time of playback of 1 VOBU, is from 0.4 seconds to 1 second.

DVD Video CD

Still picture

1 Press .

Note

- There is no sound when viewing still frames or when advancing one frame at a time.
- Pause may not be possible with certain discs. In this case, the  mark is displayed.
- When you press , playback is paused and background color (for example, blue) appears on the TV screen.



Slow motion Play

DVD Video CD

Forward slow playback

Press and hold  during playback.

To change the speed of slow playback

During slow playback, slow playback speed can be adjusted to any one of four speeds by pressing  and .

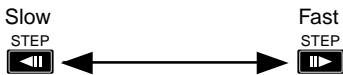

For DVD STEP1 ($1/30$) - $1/16$ - $1/8$ - $1/4$ - $1/2$ - $1/1$
 For Video CD $1/16$ - $1/8$ - $1/4$ - $1/2$
 (units: seconds)

DVD

Reverse slow playback

Press and hold  during playback.

To change the speed of slow playback

The action differs depending on the setting of the REV STEP/REV PLAY item of the ADV SETUP menu (page 48).

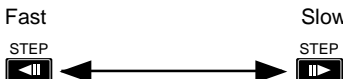

For frame: $1/1$ - $1/2$ - $1/4$ - $1/8$ - $1/16$ - STEP1 ($1/30$)
 (units: seconds)

For VOBUs*: Reverse slow playback in VOBUs units.

* **VOBU = Video Object Unit:**

In DVD-VIDEO, it is the smallest unit that forms a stream and, at the time of playback, is from 0.4 seconds to 1 second.

DVD Video CD

To return to normal playback

Press  .

Note

• No sound will be heard during slow motion play.

Repeat Play

DVD Video CD CD

Repeat play of a chapter/track

1 During playback of the chapter or track you wish to repeat, press  so that Repeat Chapter is displayed.

• With CDs and Video CDs, Repeat Track is displayed.

DVD Video CD CD

Repeat play of a title

1 During playback of the title you wish to repeat, press  so that repeat Title is displayed.

- With DVD discs, the title continues playing until the end, and then playback starts once more from the beginning of that title.
- With CDs and Video CDs, the disc is one title, therefore the entire disc is repeated.

DVD

Repeat play of all titles

1 During playback, press  so that Repeat All is displayed.

- This operation is effective only when the menu's TITLE PLAY MODE is set to All (see page 47.)
- When playback has continued until the end of the final title, playback begins again from title 1.

DVD Video CD CD

Repeat play of a specified section

1 Press  at the beginning and end of the section you want to repeat.

DVD Video CD CD

Return to a specified location

1 Press  at the desired location.



2 To return, press .

• Press  to clear a specified location.

Tips

• To cancel Repeat Play, press  the button. The Repeat play mode will be cancelled, but playback will continue normally.

Note

- With some DVD discs, there may be times when Repeat playback is not possible because of the title. In this case, the  mark will appear on the screen.
- With Video CDs, Repeat play is not possible during playback with the menu displayed (PBC playback). To perform Repeat play, start playback without displaying a menu (see page 17), and press .
- PROGRAM indicator on the main unit lights during repeat play.

Program Play

The contents of one disc can be arranged in the desired order. Programming is possible up to a maximum of 24 steps.

DVD

1 Press **MEMORY** three times.

PROGRAM is displayed on the television screen.

2 Press **ENTER**.

The program screen is displayed.

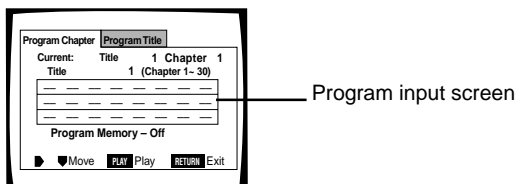

3 With **▲ ▼ ◀ ▶**, select the mode.

Program Chapter:

When programming with chapter units

Program Title:

When programming with title units

4 With **▲ ▼ ◀ ▶**, the cursor (the place where the color is changed) is moved to the program input screen.

5 With the number buttons, the chapters and titles are designated in the desired playback sequence.

Example) To program titles or chapters in the sequence

9, 7, 18, press **9**, **7**, **>10**, **1**, **8**.

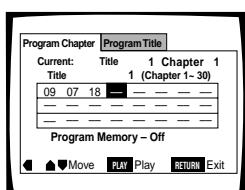

■ To input chapters and titles during playback

Press **ENTER**.

6 With **▲ ▼ ◀ ▶**, move the cursor to the chapter or title where you want to start playback

7 Press **PLAY**.

Playback starts in the programmed sequence.

- When **RETURN** is pressed, the programming ends without playback.

Note

- If the current title number (upper side) on the display is different from the title number (lower side), inputting chapters using **ENTER** is not possible. In such cases, numeric buttons to input chapters.
- In case of DVD, program play is not possible depending on disc. In such cases, or mark will appear on the screen.
- programming chapter is possible when those chapters are in the same title only.
- When the chapter is being changed to the next chapter during program play, the display of the chapter which is not programmed appears on the TV screen. It is not malfunction.

Video CD CD

1 Press **MEMORY** three times.

PROGRAM is displayed on the television screen.

2 Press **ENTER**.

The program screen is displayed.

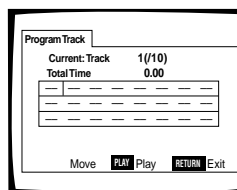

3 With the number buttons, the tracks are designated in the desired playback sequence.

Example) To program tracks in the sequence 9, 7, 18,

press **9**, **7**, **>10**, **1**, **8**.

4 With **▲ ▼ ◀ ▶**, move the cursor to the track where you want to start playback.

5 Press **PLAY**.

Playback starts in the programmed sequence.

- When **RETURN** is pressed, the programming ends without playing back.

Note

- During Video CD PBC playback, program playback is not possible.

DVD Video CD CD

To stop program play

1 Press ^{CLEAR}  during play.

Normal playback starts from the chapter/track currently playing.

Notes

- When the disc table is opened, the program will be completely erased. With DVD, a program that you want to save can be recorded in this player (page 24).
- When ^{CLEAR}  is pressed while stopped, the entire program is erased.

DVD Video CD CD

Programming a pause

1 Press ^{PAUSE}  in the program input screen.

"II" is displayed and a pause is programmed.

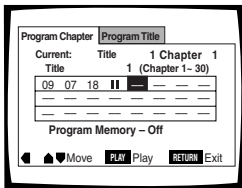

- When a pause is programmed, it pauses at the start of the title, chapter/track programmed next. To continue program playback, press ^{PLAY} .

Notes

- It is not possible to program a pause at the beginning and at the end of a program.
- It is not possible to program a pause two or more times in a row.

DVD Video CD CD



Checking a program

1 Press ^{MEMORY}  three times.

"PROGRAM" is displayed on the TV screen.

2 Press ^{ENTER} .

With a DVD, press   again and select "Program Chapter" or "Program Title".

- To start program playback, press ^{PLAY} . To end a program, press ^{RETURN} .

www.liveline.be

DVD Video CD CD

Erasing the contents of a program one by one

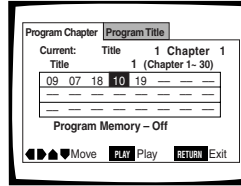

1 With    , designate the numbers that you want to erase.

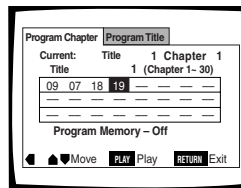

2 Press ^{CLEAR} .

The designated numbers are erased and the next numbers are moved forward one by one.



- To start program playback, press ^{PLAY} . To end a program, press ^{RETURN} .

DVD Video CD CD

Adding a program

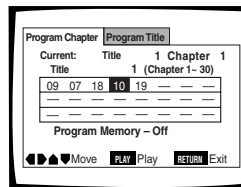

1 With    , designate the place where you want to insert.

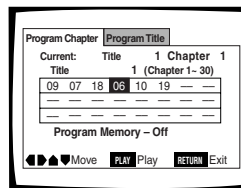

2 Press the number button.

The designated number moves back and a new number is inserted.



- To start program playback, move the cursor to the number where you want playback to start and press ^{PLAY} . To end a program, press ^{RETURN} .
- When all of the program (24 steps) has been input, add after erasing with ^{CLEAR} .

Program Play



DVD

Recording the program (program memory)

This player can record DVD programs up to a maximum of 24 discs, even if the disc is removed. When a program is recorded, program playback starts when the same disc is played back next. When the number of recorded discs exceed 24, the programs are automatically erased starting with the oldest discs.

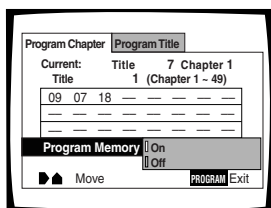

1 With    , select "ON" of "Program Memory" and press .



- To start program playback, move the cursor to the number where you want playback to start and press . To end a program, press .

DVD

Erasing the Program of the disc which is used

1 Press   to select [Off] of [Program Memory] and press .

- However, the numbers remain as they were on the program input screen, program of the disc is erased.

Viewing disc information

Viewing disc information while stopped

1 Press  while stopped.

The disc information screen is displayed.

DVD

The titles and the number of chapters within the respective titles are displayed.

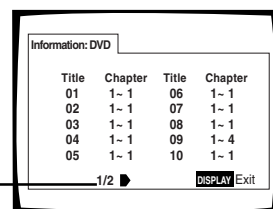

The screenshot shows a table with columns 'Title' and 'Chapter'. The first page shows titles 01-04, and the second page shows titles 05-09. A '1/2' indicator and a 'DISPLAY Exit' button are at the bottom.

Title	Chapter	Title	Chapter
01	1-1	05	1-1
02	1-1	07	1-1
03	1-1	08	1-1
04	1-1	09	1-4
05	1-1	10	1-1

1/2 shows that there are two pages of information, and that this screen is the first of those pages.

When there are two or more pages of disc information, the next screen is displayed when the cursor button  (right direction) is pressed.

Video CD CD

The tracks and the respective track times are displayed.

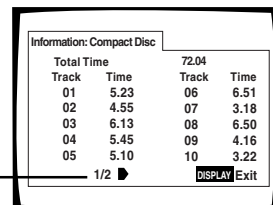

The screenshot shows a table with columns 'Track' and 'Time'. The first page shows tracks 01-05, and the second page shows tracks 06-10. A 'Total Time' of 72:04 is shown at the top. A '1/2' indicator and a 'DISPLAY Exit' button are at the bottom.

Track	Time	Track	Time
01	5.23	06	6.51
02	4.55	07	3.18
03	6.13	08	6.50
04	5.45	09	4.16
05	5.10	10	3.22

1/2 shows that there are two pages of information, and that this screen is the first of those pages.

When there are two or more pages of disc information, the next screen is displayed when the cursor button  (right direction) is pressed.

To switch off the disc information

Press  again. The disc information screen disappears.

Viewing disc information during playback

1 Press **DISPLAY** repeatedly during playback.

When pressed, the following kind of disc information is displayed in the upper part of the screen.

DVD

When pressed **once**, the present frame information is displayed.

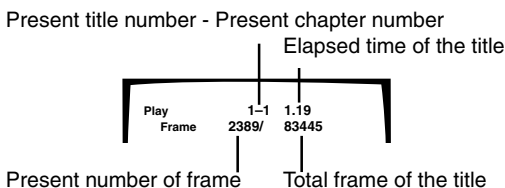

When pressed **twice**, the present title information is displayed.

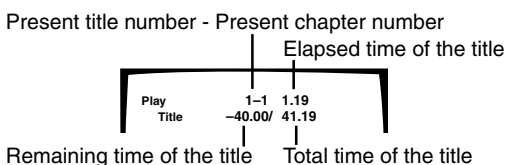

When pressed **three times**, the present chapter information is displayed.

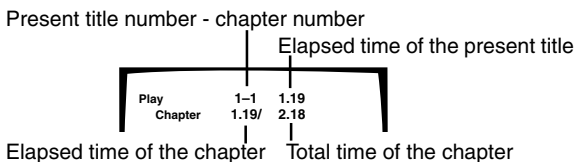

When pressed **four times**, the present chapter information is further displayed.

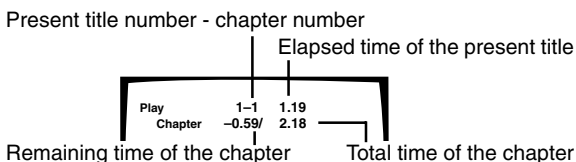

When pressed **five times**, the transfer rate* level meter is displayed.

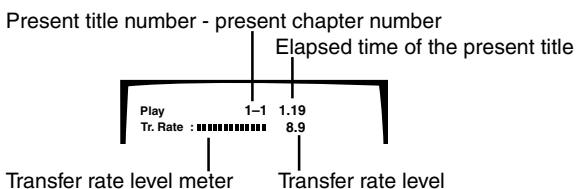

* It is the value that shows the amount of information of the picture recorded on the DVD. The higher the level of the transfer rate, the greater the amount of information, but the picture quality may not always be good.

When pressed **six times**, the display screen disappears.

Video CD

When pressed **once**, the present information of the video CD is displayed.

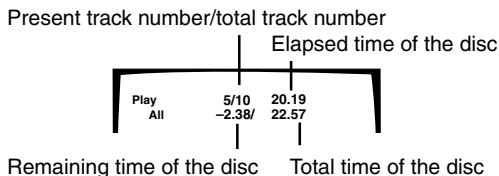

When pressed **twice**, the present track information is displayed.

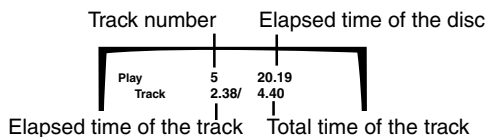

When pressed **three times**, the present track information is further displayed.

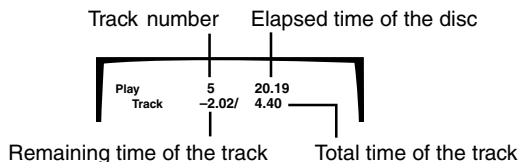

When pressed **four times**, the display screen disappears.

- Disc information can't be viewed during PBC playback of a Video CD.

CD

When pressed **once**, the present track information is displayed.

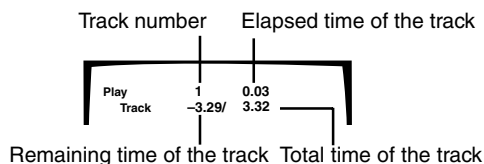

When pressed **twice**, the present information of the CD is displayed.

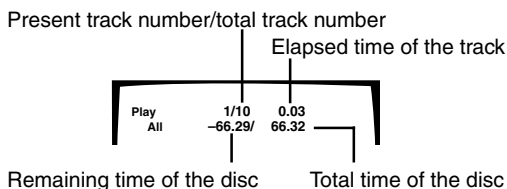

When pressed **three times**, the display screen disappears.

Switching the Angle of the Image (Multi-Angle)

DVD

With DVDs featuring recordings of pictures shot from different angles, you can choose any desired viewing angle during playback. The  mark is placed on the jacket of a DVD that has multiple angles.



1 If the  mark is displayed during playback, press **ANGLE**.

2 Press **ANGLE** again to select the desired angle.

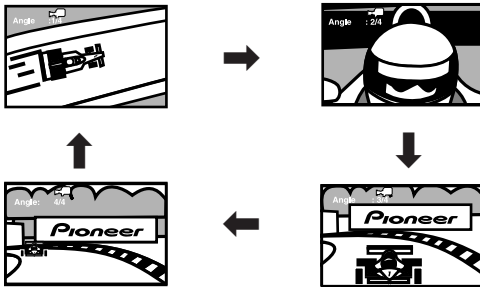
The angle changes each time **ANGLE** is pressed.



Note

-  is displayed on the screen when you come to a place where multiple angles have been recorded.
- When the angle is switched during a pause, the pause is cleared.
- In some DVDs the angle can be switched also in the disc menu screen.
- When you do not want  to be displayed, set the [Angle Indicator] to off in the initial setup menu (page 32).

Switching the Subtitles during Playback

DVD

When a DVD with subtitles that have been recorded in multiple languages is being played back, the subtitles displayed can be changed.

1 Press **SUBTITLE** during playback of the DVD.

The currently selected subtitles are displayed.

2 Press the **SUBTITLE** button again.

The subtitle display changes each time **SUBTITLE** is pressed.

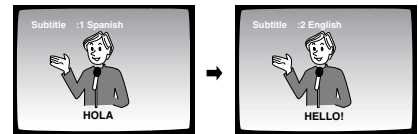

Note

- To cancel the subtitles, press **CLEAR** after pressing **SUBTITLE**, or press **SUBTITLE** and select [OFF].
- In some DVDs subtitle can be switched also in the disc menu screen. In that case, press **MENU** and select after the menu is displayed. (page 17)
- The subtitle language here is temporary. When playback has been stopped, it returns to the subtitle language selected by [Subtitle Language] (page 33) of the initial setup menu.

Switching the Audio during Playback

DVD

When a DVD with audio that has been recorded in multiple languages is being played back, the audio played back can be changed.

1 Press **AUDIO** while playing back the DVD.

The currently selected audio is displayed.

2 Press **AUDIO** again.

The audio changes each time **AUDIO** is pressed.

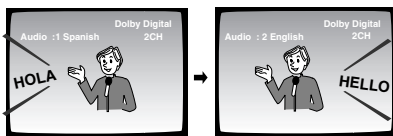

Note

- Switching the audio of the DVD may also be performed in the menu screen. In that case, press **MENU** and select after the menu is displayed. (page 17)
- The audio language switched here is temporary. When playback has been stopped, it returns to the audio language selected by [Audio Language] (page 33) of the initial setup menu.
- The picture may momentarily stop when the audio changes depending on the disc.

Switching the stereo/ left/right Audio

Video CD | CD

The type of audio of Video CDs and CDs can be switched.

1 Press **AUDIO** during playback of a Video CD or CD.

Each time the button is pressed, the audio changes to stereo, 1/L (left) and 2/R (right).

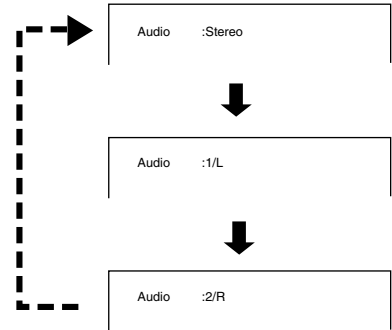

Note

- With Karaoke, etc., perform the above-mentioned operation and set to the type of audio written on the disc jacket, etc. to make the audio the accompaniment only.

Index of the Graphical User Interface (GUI)

On this player, various settings can be selected while watching menu screens. Here we will explain how to access menu screens. Because menu screen access differs according to the type of disc being used, or the playback mode (stop mode etc.), refer to the following menu map when accessing.

Audio1	2	Video	Language	General
Dolby Digital Out	<input checked="" type="checkbox"/>	Dolby Digital	page 40
		Dolby Digital	▶ PCM	
DTS Out	<input checked="" type="checkbox"/>	Off	page 40
		DTS		
96kHz PCM Out	<input checked="" type="checkbox"/>	96kHz	▶ 48kHz
		96kHz		page 41
MPEG Out	<input checked="" type="checkbox"/>	MPEG	page 41
		MPEG	▶ PCM	
Digital Out	<input checked="" type="checkbox"/>	On	page 42
		Off		

1	Audio2	Video	Language	General
Virtual Surround	<input checked="" type="checkbox"/>	Off	page 42
		VDD/Tru Surround		
Audio DRC	<input checked="" type="checkbox"/>	Large	page 43
		Medium		
		Small		
		<input checked="" type="checkbox"/> Off		

Audio1	2	Video	Language	General
TV Screen	<input checked="" type="checkbox"/>	4:3 (Letter Box)	page 29
		4:3 (Pan & Scan)		
		<input checked="" type="checkbox"/> 16:9 (Wide)		
Still Picture	<input checked="" type="checkbox"/>	Field	page 31
		<input checked="" type="checkbox"/> Frame		
		Auto		
On Screen Display	<input checked="" type="checkbox"/>	On	page 31
		Off		
OSD Position	<input checked="" type="checkbox"/>	Wide	page 32
		<input checked="" type="checkbox"/> Normal		
Angle Indicator	<input checked="" type="checkbox"/>	On	page 32
		Off		

Audio1	2	Video	Language	General
Audio Language	<input checked="" type="checkbox"/>	English	page 33
		Other		
Subtitle Language	<input checked="" type="checkbox"/>	English	page 33
		Other		
Auto Language	<input checked="" type="checkbox"/>	On	page 34
		Off		
DVD Language	<input checked="" type="checkbox"/>	w/ Subtitle Language	page 35
		English		
		Other		
Subtitle Display	<input checked="" type="checkbox"/>	On	page 35
		Off		
		Assist Subtitle		
Subtitle Off	<input checked="" type="checkbox"/>	With Audio	page 36
		<input checked="" type="checkbox"/> Selected Subtitle		

Audio1	2	Video	Language	General
Parental Lock	<input checked="" type="checkbox"/>	Level Change	page 37
		Password Change		
Screen Saver	<input checked="" type="checkbox"/>	Off	page 39
		Black		
		Background Color		
Background Color	<input checked="" type="checkbox"/>		page 39

indicates the setting when shipped

Operating the Initial Setup Menu

DVD Video CD CD

The initial setup menu enables various settings to be made. The basic operating method for the initial setup menu and the locations of the buttons used are explained next.

■ Displaying the initial setup menu

1 Press  .

When the power has been turned on, proceed to **2**.

2 Press  .

The initial setup menu is displayed.

Example)

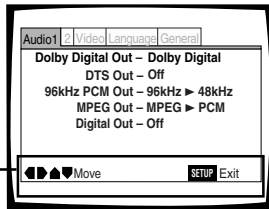

The buttons that can be operated from the screen.

■ Settings that work immediately after changing, depending on the type of disc

Depending on the type of disc, whether DVD, Video CD or CD, some settings work immediately after changing. This player provides confirmation by the color of the indicator to the left of the selected setting. See the following table.

Color of the indicator	Type of disc
Blue	DVD only
Yellow	DVD/Video CD only
Green	Not affected by the type of disc

■ Settings that cannot be changed during playback

Those settings that cannot be changed during playback are displayed in gray.

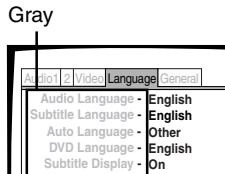

Selecting the aspect ratio

DVD

Set the aspect ratio to match the television connected to this player. This setting is unnecessary when connected to a wide-screen television.

Most DVD movies support a wide-screen television and the screen size ratio (usually called the aspect ratio) is set to 16:9 (horizontal:vertical). Consequently, if a DVD is viewed on a television of the conventional size, the 4:3 aspect ratio has the effect of increasing the height of the image. Set the aspect ratio to 4:3 when viewing on a television of the conventional size to eliminate this distortion. This setting cannot be changed during playback.

1 Press  .

The initial setup menu is displayed.

2 Select [Video].

3 Select [TV Screen].

4 Press the cursor button  (right direction).

5 Select the preferred item.

6 Press  .

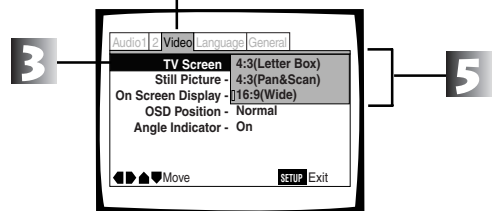

4:3 (Letter Box):

Select when a television of the conventional size is connected and you want to view in the letter box format (see the next page).

4:3 (Pan & Scan):

Select when a television of the conventional size is connected and you want to view in the pan & scan format (see the next page).

16:9 (Wide):

Select when a wide-screen television (16:9) is connected (Setting when shipped).

7 Press  .







- If a 16:9 disc with 96 kHz PCM sound is converted to letter box format and played back, the sampling frequency of the sound will be downgraded to 48 kHz. To enjoy the sound at 96 kHz, set the screen aspect ratio to wide-screen.
- Whether the aspect can be changed or not depends on the disc. Check the disc jacket, etc. for details.

Selecting the aspect ratio





DVD

The images which appear in the TV

Regular TV (4:3)

Image recorded on DVD	Settings of this player	Way to view the image
 <p>16:9 discs</p>	4:3 (Letter Box)	 <p>There are bands at the top and bottom, but it can be properly viewed</p>
	4:3 (Pan & Scan)	 <p>The left and right sides of the screen are cut off, but it can be properly viewed When you don't want to view the picture in this way, switch the setting of this player to [4:3 (Letter Box)].</p>
	16:9 (Wide)	 <p>Appears to be lengthened vertically When the picture appears in this way, switch the settings of this player to [4:3 (Letter Box)] or [4:3 (Pan & Scan)].</p>
 <p>4:3 discs</p>	4:3 (Letter Box) 4:3 (Pan & Scan) 16:9(Wide)	 <p>It can be viewed properly</p>

Wide TV (16:9)

Image recorded on DVD	Settings of this player	Way to view the image
 <p>16:9 discs</p>	16:9 (Wide)	 <p>It can be viewed properly There are bands at the top and bottom depending on the disc.</p>
 <p>4:3 discs</p>	16:9 (Wide)	 <p>There are bands at the right and left, but it can be properly viewed</p>
		 <p>Appears to be lengthened horizontally When the picture appears in this way, adjust the setting of TV to normal. Refer to the operating instruction of TV for details.</p>

NOTE

When following operation is operated during playback in the letter box or Pan & Scan modes, the screen size is forcibly changed to the wide-screen mode

- When setup menu is displayed.
- When command stack is displayed.
- When video text is displayed.
- When ADV.SETUP menu is displayed.
- When video blackboard is displayed.
- When player control panel is displayed.
- When program is displayed.

Changing visual setting

DVD

Switching still pictures

Eliminating the burriness of a picture when the DVD has paused, and viewing the picture clearly is possible.

1 Press **SETUP**.

The initial setup menu is displayed.

2 Select **[Video]**.

3 Select **[Still Picture]**.

4 Press the cursor button  (right direction).

5 Select the preferred item.

6 Press **ENTER**.

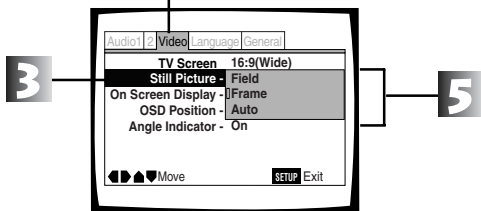

Field: Eliminates the burriness of the picture when in the still picture state.

Frame: Normal mode. (Setting when shipped)

- Scenes that the picture moves dynamic, jittering occurs in the still picture.

Auto: Field and Frame automatically switch.

7 Press **SETUP**.

Note

- Depending on the disc, there are times when the picture quality may not become clear, even if "Field" is selected.

DVD Video CD CD

Switching the screen display on/off

The setting can be changed when you don't want to have the display when this player is operated such as "Play" and "Stop" displayed in the television screen.

1 Press **SETUP**.

The initial setup menu is displayed.

2 Select **[Video]**.

3 Select **[On Screen Display]**.

4 Press the cursor button  (right direction).

5 Select the preferred item.

6 Press **ENTER**.

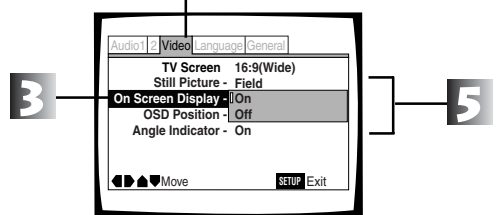

On: Displays screen. (Setting when shipped)

Off: Does not display screen.

7 Press **SETUP**.

Changing visual settings

DVD

Selecting the position of the OSD

The OSD position of the initial startup screen such as “Play” or “Stop”, etc. which this player displays can be set to suit the type of television. Set the screen ratio of the DVD disc to 4:3. (for details check the disc jacket, etc.)

1 Press .

The initial setup menu is displayed.

2 Select [Video].

3 Select [OSD Position].

4 Press the cursor button  (right direction).

5 Select the preferred item.

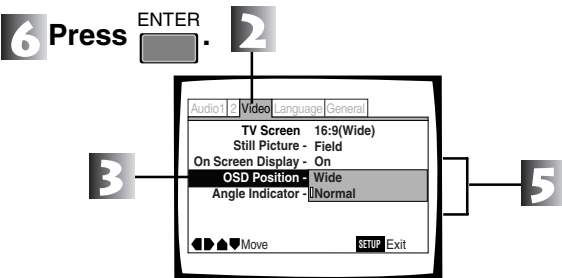

Wide: This setting avoids cutting off part of the OSD when zoom has been selected with the wide-screen television setting.

Normal: Select this when normal or full have been selected with the wide-screen television setting (Setting when shipped).

7 Press .

DVD

Turning the mark on/off

Change the setting when you don't want to display the  mark that is displayed on the screen during playback.

1 Press .

The initial setup menu is displayed.

2 Select [Video].

3 Select [Angle Indicator].

4 Press the cursor button  (right direction).

5 Select the preferred item.

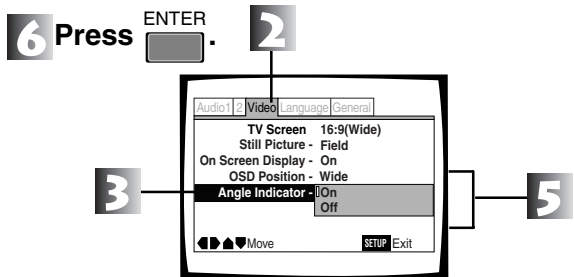

On: Display the  mark on the screen. (Setting when shipped)

Off: Does not display the  mark on the screen.

7 Press .

Setting the Language

Some DVD discs have multiple subtitles and audio tracks and have a function that enables the user to select the one he/she wants to suit his/her needs. The settings related to the various languages and subtitles in (Language) of the initial setup screen are explained here.

DVD

Setting the audio language

Select the audio language.
This setting cannot be changed during playback.

1 Press **SETUP**.

The initial setup menu is displayed.

2 Select [Language].

3 Select [Audio Language].

4 Press the cursor button (right direction).

5 Select the preferred item.

6 Press **ENTER**.

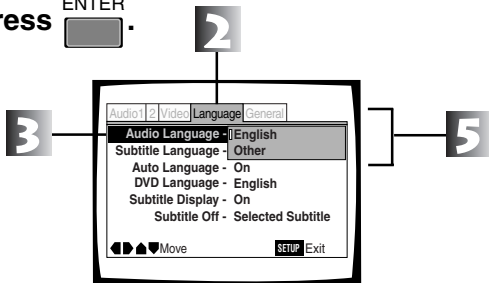

English: The audio language is English.
(Setting when shipped).

Other: Select the desired audio from among 136 languages. See "When [Other] is selected by the subtitle language/ audio language/ DVD language setting" on the next page for details.

7 Press **SETUP**.

DVD

Setting a subtitle language

Select the subtitle language displayed.
This setting cannot be changed during playback.

1 Press **SETUP**.

The initial setup menu is displayed.

2 Select [Language].

3 Select [Subtitle Language].

4 Press the cursor button (right direction).

5 Select the preferred item.

6 Press **ENTER**.

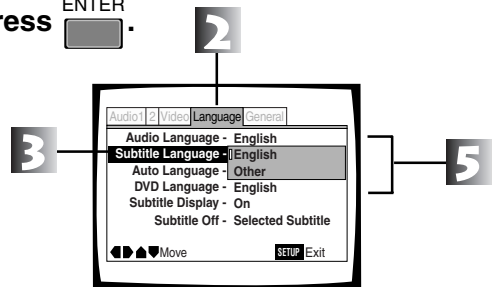

English: Displays English language subtitles.
(Setting when shipped)

Other: Select the desired subtitle from among 136 languages. For details, see "When [Other] is selected by the subtitle language/ audio language/ DVD language setting" on the next page.

7 Press **SETUP**.

Setting the Language

■ When (Other) is selected by the subtitle language/ audio language/ DVD language setting

Operate while viewing the language code table on page 44.

1 Select [Other].

2 Press .

The language setting screen is displayed.

Example) Audio Language is displayed

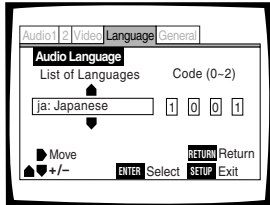







3 Select [List of Languages] or [Code].

■ Selecting the language with the “List of Languages” (When selecting “French”)

Press  twice.

■ Selecting a language with the “Code” (When selecting “French”)

Press the remote control number buttons   

● The numbers can also be selected by pressing   for each digit.

Pressing the   shifts the digit.

● The numbers in the () of the code show the range of the numbers that can be set.

4 Press .

DVD

Automatically setting the audio and subtitles

You can select whether the audio and subtitles are selected automatically or by the initial startup setting.

This setting cannot be changed during playback.

1 Press .

The initial setup menu is displayed.

2 Select [Language].

3 Select [Auto Language].

4 Press the cursor button (right direction).

5 Select the preferred item.

6 Press .

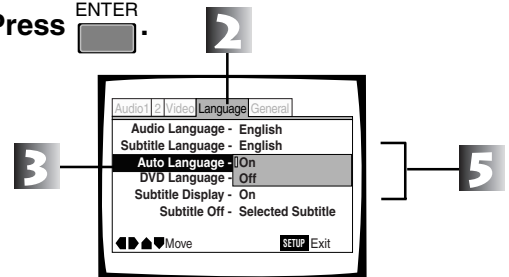

On: This is effective when the audio language and the subtitle language are the same and when the subtitle display is On. With a foreign movie DVD, the original language is selected for the audio and the language selected in the [Subtitle Language] menu option is selected for the subtitles ; with a domestic movie DVD, the original language is selected for the audio and the subtitles are off; (Setting when shipped).

Off: Automatic setting of the audio during playback is cancelled, and the audio and subtitle language is set as already set by [Audio Language] and [Subtitle Language].

7 Press .

DVD

Setting the DVD menu language

Some DVDs have a menu. Select the language from this menu. This setting cannot be set during playback.

1 Press **SETUP**.

The initial setup menu is displayed.

2 Select **[Language]**.

3 Select **[DVD Language]**.

4 Press the cursor button **▶** (right direction).

5 Select the preferred item.

6 Press **ENTER**.

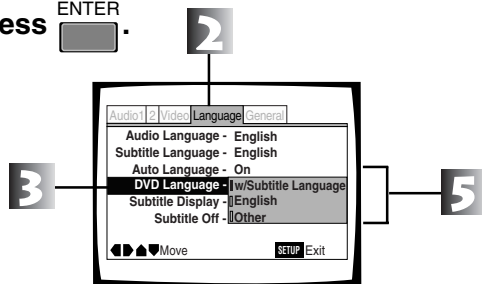

- w/Subtitle Language: Menu screen is displayed with the language selected by the subtitle language. (Setting when shipped)
- English: The menu screen is displayed in English.
- Other: Select the desired language from among 136 languages. For details, see “When [Other] is selected by the subtitle language/ audio language/DVD language setting” on page 34.

7 Press **SETUP**.

Note
When a language that is not recorded on the DVD has been set, the menu screen is displayed with one of the languages recorded.

DVD

Turning the subtitle display on/off

Select whether subtitles are to be displayed or not, or whether “Assist Subtitle” is to be displayed. This setting cannot be changed during playback.

1 Press **SETUP**.

The initial setup menu is displayed.

2 Select **[Language]**.

3 Select **[Subtitle Display]**.

4 Press the cursor button **▶** (right direction).

5 Select the preferred item.

6 Press **ENTER**.

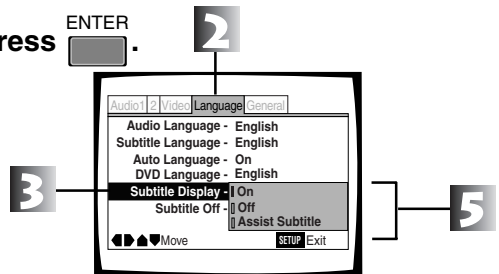

- On: The subtitles are displayed (Setting when shipped).
- Off: The subtitles are not displayed. However, some DVDs enforce the display of subtitles (See the next page).
- Assist subtitle: An assist subtitle is one which, for example, helps to explain a scene for persons who are hearing impaired. The assist subtitles are displayed when this setting is selected, but only if they have been recorded on the disc.

7 Press **SETUP**.

Setting the Language

DVD

Setting the language of the subtitles with enforced display

Some DVDs enforce the display of subtitles even when subtitle display “Off” has been selected. However, the language of the subtitles can still be selected in the normal way. This setting cannot be changed during playback.

1 Press ^{SETUP} .

The initial setup menu is displayed.

2 Select [Language].

3 Select [Subtitle Off].

4 Press the cursor button  (right direction).

5 Select the preferred item.

6 Press ^{ENTER} .

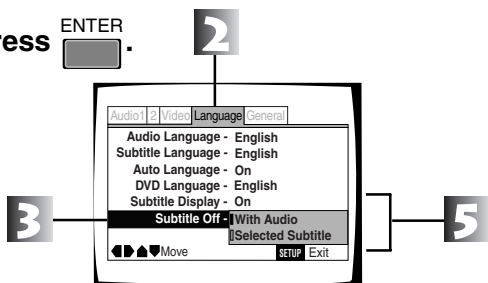

With Audio: Subtitles are displayed in the language of the audio that is being played back.

Selected Subtitle: Subtitles are displayed in the language selected by “Subtitle Language” on the initial setup menu (Setting when shipped).

7 Press ^{SETUP} .

Setting viewing and listening restrictions (Parental Lock)

Some DVDs that contain violent scenes incorporate viewing restriction levels (great and small). This information is displayed on the disc jacket. If the level of this player has been set to a level lower than the level of a disc, (it is not possible to view and listen to that disc.) For example, if the level of this player has been set to 6, a special code number has to be input before discs of levels 7 and 8 can be played back.

DVD

Setting the restriction level

The level of the viewing and listening restrictions and the special code number are set manually.

1 Press **SETUP**.

The initial setup menu is displayed.

2 Select **[General]** with **◀ ▶**.

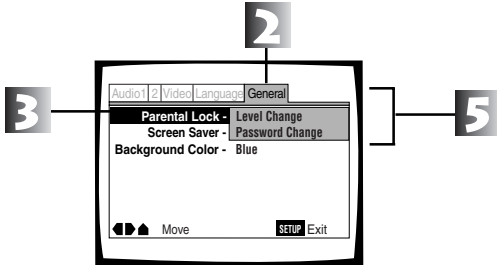

3 Select **[Parental Lock]** with **▲ ▼**.

4 Press the cursor button **▶** (right direction).

5 Select **[Level Change]** with **▲ ▼**, and then press **ENTER**.

■ When a code number has not yet been registered:
The code number registration screen is displayed.

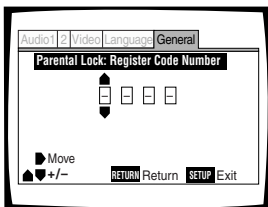

■ When the code number has already been registered:
The code number input screen is displayed.

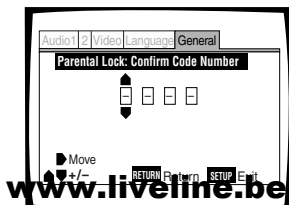

6 Press the number buttons and input the code number as 4 digits.

- Pressing **▲ ▼** for each digit and selecting the numbers is also possible. Pressing **◀ ▶** moves the digit.

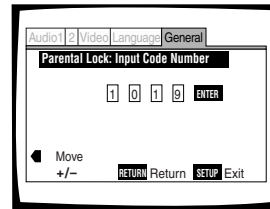

7 Press **ENTER**.

The viewing and listening restriction level setting screen is displayed.

- The setting at the time of shipment is level 8 (unrestricted).

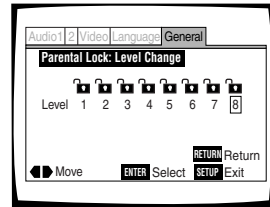

8 With **◀ ▶**, select the appropriate number for the level.

For example, if level 6 has been selected, viewing and listening restrictions are applied with respect to any discs of levels 7 and 8.

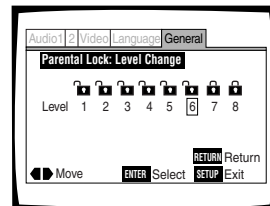

9 Press **ENTER**.

The level of the viewing and listening restrictions is set.

Notes:

We recommend you make a note of the code number.

If you forget the code number, return to the setting when shipped (page 44) and then reset it.





Setting viewing and listening restrictions (Parental Lock)

DVD

When a DVD with a set Parental Lock level is loaded

When a DVD with a set Parental Lock level is loaded, password input screen may be displayed. Playback cannot be started until the password has been correctly input.

1 Press the number buttons and input the code number as 4 digits.

- Pressing   for each digit and selecting the numbers is also possible. Pressing   moves the digit.

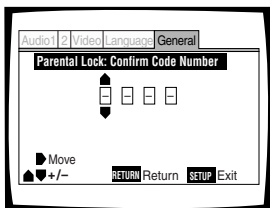

2 Press .

Playback starts.

Note:

Some discs will skip while playing back only the scenes that have had their viewing and listening restricted. See the operation method for with the disc to get details.

DVD

Changing the code number



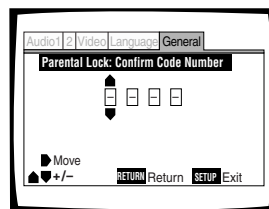

1 Perform the operations of procedures 1 ~ 4 “Setting the restriction level” on the previous page

2 Press , select [Password Change], and press .

The code number input screen is displayed.



3 Press the number buttons and input the present code number with 4 digits.

- Pressing   for each digit and selecting the numbers is also possible. Pressing   moves the digit.

4 Press .

The code number changing screen is displayed.

5 Press the number buttons and input the new code number as 4 digits.

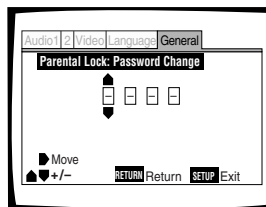

6 Press .

The code number is changed.

Making the ordinary settings

DVD Video CD CD

Setting the screen saver

The screen saver is a function to prevent the burning in (the afterglow phenomenon) of an image when the same image has been displayed for a long time such as during a pause.

1 Press **SETUP**.

The initial setup menu is displayed.

2 Select [General].

3 Select [Screen Saver].

4 Press the cursor button  (right direction).

5 Select the preferred item.

6 Press **ENTER**.

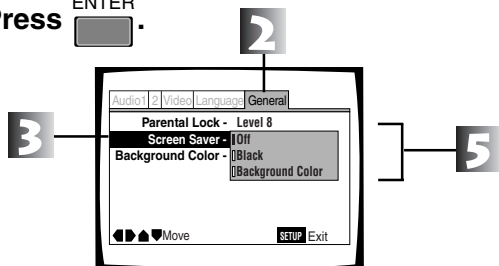

- Off: The screen saver function does not work. (Setting when shipped)
- Black: Screen saver set to black.
- Background color: Screen saver set to background color.

7 Press **SETUP**.

DVD Video CD CD

Select the background color

Select the color of the screen when the disc has stopped.

1 Press **SETUP**.

The initial setup menu is displayed.

2 Select [General].

3 Select [Background Color].

4 Press the cursor button  (right direction).

5 Press **ENTER**.

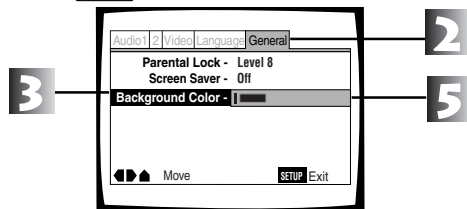

6 Adjust the coloring with the screen below and press **ENTER**.

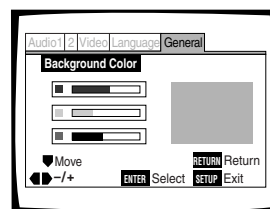

7 Press **SETUP**.

Setting the Digital Output

The type of digital signal that corresponds to the amplifier connected to this player can be selected. Be careful because noise may occur when the appropriate setting is not made.

Read this together with the operation manual of the amplifier that you have.

DVD

Dolby Digital Output

When the connected amplifier does not support Dolby Digital*, set to [Dolby Digital ▶ PCM].

1 Press .

The initial setup menu is displayed.

2 Select [Audio 1].

3 Select [Dolby Digital Out].

4 Press the cursor button  (right direction).

5 Select the preferred item.

6 Press .

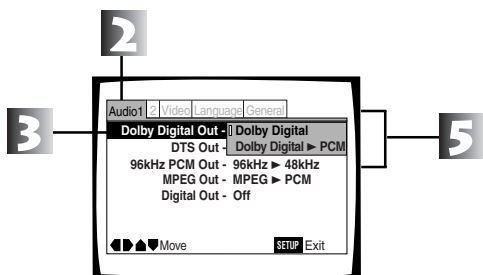

Dolby Digital: Select when connected to an amplifier or decoder that supports Dolby Digital. (Setting when shipped)

Dolby Digital ▶ PCM: Converts a Dolby Digital signal to a linear PCM signal and outputs. Select when connected to an amplifier that does not support Dolby Digital.

7 Press .

* Manufactured under license from Dolby Laboratories. "Dolby" and the double-D symbol are trademarks of Dolby Laboratories. Confidential unpublished works. © 1992-1997 Dolby Laboratories. All rights reserved.

DVD

DTS Output

When the connected amplifier supports DTS**, set to [DTS].

1 Press .

The initial setup menu is displayed.

2 Select [Audio 1].

3 Select [DTS Out].

4 Press the cursor button  (right direction).

5 Select the preferred item.

6 Press .

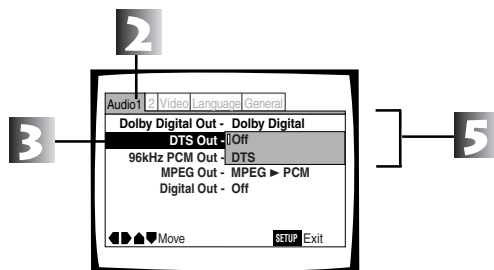

Off: Select when connected to an amplifier that does not support DTS. (Setting when shipped)

DTS: Select when connected to an amplifier or decoder that supports DTS.

7 Press .

** "DTS" and "DTS Digital" are trademarks of Digital Theater Systems, Inc. Manufactured under license from Digital Theater Systems, Inc.

DVD

96 kHz PCM Output

When the connected amplifier supports 96 kHz, set to (96 kHz). This setting cannot be changed during playback.

1 Press .

The initial setup menu is displayed.

2 Select [Audio 1].

3 Select [96kHz PCM Out].

4 Press the cursor button  (right direction).

5 Select the preferred item.

6 Press .

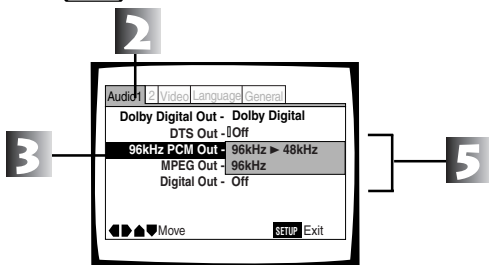

96 kHz ▶ 48 kHz: Down-samples a 96 kHz signal to 48 kHz and outputs. Select when connected to an amplifier that does not support 96 kHz. (Setting when shipped)

96 kHz: Select when connected to an amplifier or DAC that supports 96 kHz.

7 Press .

DVD

MPEG Output

When the connected amplifier supports MPEG, set to (MPEG).

1 Press .

The initial setup menu is displayed.

2 Select [Audio 1].

3 Select [MPEG Out].

4 Press the cursor button  (right direction).

5 Select the preferred item.

6 Press .

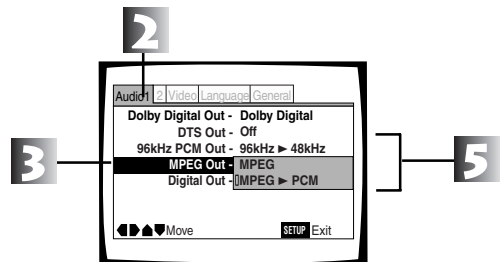

MPEG: Select when connected to an amplifier or decoder that supports MPEG.

MPEG ▶ PCM: Converts an MPEG signal to a linear PCM signal and outputs. Select when connected to an amplifier that does not support MPEG. (Setting when shipped)

7 Press .

Setting the Digital Output

DVD Video CD CD

Setting the Digital Output

Can be set so that an audio signal is not output from the digital audio output terminal.

1 Press **SETUP**.

The initial setup menu is displayed.

2 Select [Audio 1].

3 Select [Digital Out].

4 Press the cursor button (right direction).

5 Select the preferred item.

6 Press **ENTER**.

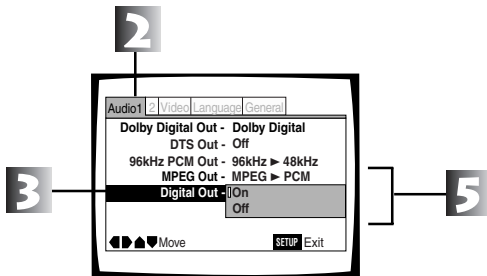

On: Outputs audio from the rear digital output terminal. (Setting when shipped)
Off: Audio is not output from the rear digital output terminal.

7 Press **SETUP**.

Settings to Optimize the Audio Quality

DVD Video CD

Surround Setting

This player automatically switches to Virtual Dolby Digital and TruSurround in line with the playback audio.

1 Press **SETUP**.

The initial setup menu is displayed.

2 Select [Audio 2].

3 Select [Virtual Surround].

4 Press the cursor button (right direction).

5 Select [VDD/TruSurround].

6 Press **ENTER**.

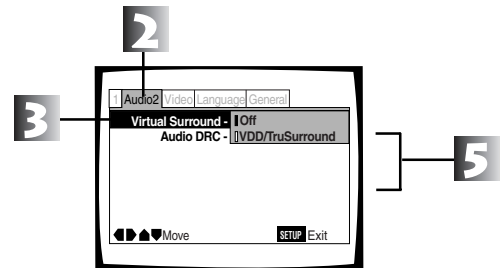

Off : Does not work. (Setting when shipped)
VDD/TruSurround : Surround sound setting

7 Press **SETUP**.

Returning to the default settings at the time of shipment

DVD Video CD CD

All the settings can be returned to the default state at the time of shipment.

When this operation is performed, all the data stored in the memory (page 24) will be simultaneously erased. Be sufficiently careful before returning to the default settings.

1 With power to the unit in the standby status, Press and hold  of the player and press  of the player.

Some of the settings are returned to the default status at the time of shipping but the other does not returned.

Setting which is returned to the default status

SETUP menu, ADV. SETUP menu, program memory, parental lock.

Setting which is not returned to the default status

Command stack, Video blackboard data, clock

Language code list

DVD

Language (Language code)	Input code
Japanese (ja)	1001
English (en)	0514
French (fr)	0618
German (de)	0405
Italian (it)	0920
Spanish (es)	0519
Dutch (nl)	1412
Russian (ru)	1821
Chinese (zh)	2608
Korean (ko)	1115
Greek (el)	0512
Afar (aa)	0101
Abkhazian (ab)	0102
Afrikaans (af)	0106
Amharic (am)	0113
Arabic (ar)	0118
Assamese (as)	0119
Aymara (ay)	0125
Azerbaijani (az)	0126
Bashkir (ba)	0201
Byelorussian (be)	0205
Bulgarian (bg)	0207
Bihari (bh)	0208
Bislama (bi)	0209
Bengali (bn)	0214
Tibetan (bo)	0215
Breton (br)	0218
Catalan (ca)	0301
Corsican (co)	0315
Czech (cs)	0319
Welsh (cy)	0325
Danish (da)	0401
Bhutani (dz)	0426
Esperanto (eo)	0515
Estonian (et)	0520

Language (Language code)	Input code
Basque (eu)	0521
Persian (fa)	0601
Finnish (fi)	0609
Fiji (fj)	0610
Faroese (fo)	0615
Frisian (fy)	0625
Irish (ga)	0701
Scots-Gaelic (gd)	0704
Galician (gl)	0712
Guarani (gn)	0714
Gujarati (gu)	0721
Hausa (ha)	0801
Hindi (hi)	0809
Croatian (hr)	0818
Hungarian (hu)	0821
Armenian (hy)	0825
Interlingua (ia)	0901
Interlingue (ie)	0905
Inupiak (ik)	0911
Indonesian (in)	0914
Icelandic (is)	0919
Hebrew (iw)	0923
Yiddish (ji)	1009
Javanese (jw)	1023
Georgian (ka)	1101
Kazakh (kk)	1111
Greenlandic (kl)	1112
Cambodian (km)	1113
Kannada (kn)	1114
Kashmiri (ks)	1119
Kurdish (ku)	1121
Kirghiz (ky)	1125
Latin (la)	1201
Lingala (ln)	1214
Laothian (lo)	1215

Language (Language code)	Input code
Lithuanian (lt)	1220
Latvian (lv)	1222
Malagasy (mg)	1307
Maori (mi)	1309
Macedonian (mk)	1311
Malayalam (ml)	1312
Mongolian (mn)	1314
Moldavian (mo)	1315
Marathi (mr)	1318
Malay (ms)	1319
Maltese (mt)	1320
Burmese (my)	1325
Nauru (na)	1401
Nepali (ne)	1405
Norwegian (no)	1415
Occitan (oc)	1503
Oromo (om)	1513
Oriya (or)	1518
Panjabi (pa)	1601
Polish (pl)	1612
Pashto, Pushto (ps)	1619
Portuguese (pt)	1620
Quechua (qu)	1721
Rhaeto-Romance (rm)	1813
Kirundi (rn)	1814
Romanian (ro)	1815
Kinyarwanda (rw)	1823
Sanskrit (sa)	1901
Sindhi (sd)	1904
Sangho (sg)	1907
Serbo-Croatian (sh)	1908
Sinhalese (si)	1909
Slovak (sk)	1911
Slovenian (sl)	1912
Samoan (sm)	1913

Language (Language code)	Input code
Shona (sn)	1914
Somali (so)	1915
Albanian (sq)	1917
Serbian (sr)	1918
Siswati (ss)	1919
Sesotho (st)	1920
Sundanese (su)	1921
Swedish (sv)	1922
Swahili (sw)	1923
Tamil (ta)	2001
Telugu (te)	2005
Tajik (tg)	2007
Thai (th)	2008
Tigrinya (ti)	2009
Turkmen (tk)	2011
Tagalog (tl)	2012
Setswana (tn)	2014
Tonga (to)	2015
Turkish (tr)	2018
Tsonga (ts)	2019
Tatar (tt)	2020
Twi (tw)	2023
Ukrainian (uk)	2111
Urdu (ur)	2118
Uzbek (uz)	2126
Vietnamese (vi)	2209
Volapük (vo)	2215
Wolof (wo)	2315
Xhosa (xh)	2408
Yoruba (yo)	2515
Zulu (zu)	2621

Advanced Feature Operations

In the Basic Operation edition, basic handling of this unit is explained. In this Advanced Features edition, however, original features of this unit are explained.

● Using the ADV.SETUP Menu

This player, in addition to the SETUP menu, has an ADV.SETUP menu for setting special functions such as the weekly timer and power-on start.

● Player control using mouse

Control method using the mouse is explained in this section.

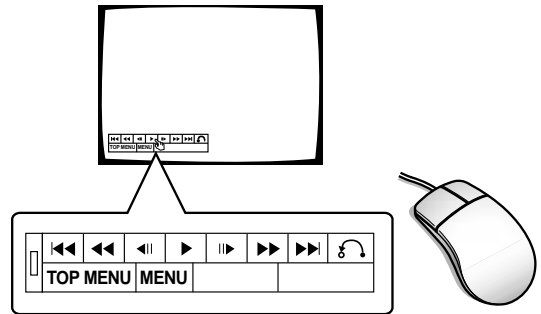

● Barcode/command stack function

Various barcodes or commands used to control the DVD-V7300D can be stored in this player's memory in advance. Memorized content can be recalled for successive or step by step execution.

With this function, program playback is possible using the player alone without the need for a computer, controller or advance registration of barcodes. (Memorized data is not erased even if the AC power cord is unplugged.)

Uses

- Sale promotion presentation
- Picture reference/Picture exhibition
- Education/training

Input

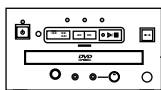
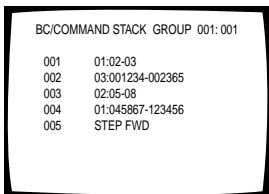

Input

Command input with provided remote control unit

Input

Barcode input with barcode reader



Playback

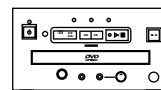

Automatic playback

- Provided remote control unit
- External option switch
- Successive playback/repeat with Weekly timer/Power on start

Manual playback

Step by step playback with provided remote control unit

● Video blackboard function

Using the mouse and keyboard, pictures, lines and characters (alphabet, numbers, symbols) can be drawn during video playback or displayed alone.

Free lines can be drawn on the picture during playback, and pre-drawn drawings or characters can be superimposed on the image and displayed at a specified position during playback. (Memorized data is not erased even if the AC power cord is unplugged.)

How to use

- A pointer
- For picture subtitle
- For picture explanation
- For picture masking

Uses

- Sale promotion presentation
- Education/training

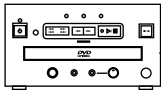
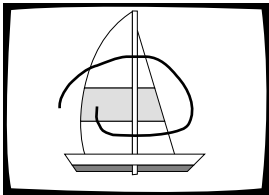

Curved lines can be drawn with the mouses

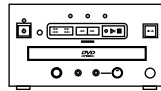
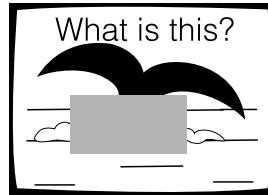

Pre-drawn drawings or characters can be automatically superimposed on the picture

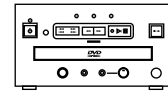

● External synchronizing function

● Playback time/Power supply time display

ADV. SETUP MENU settings

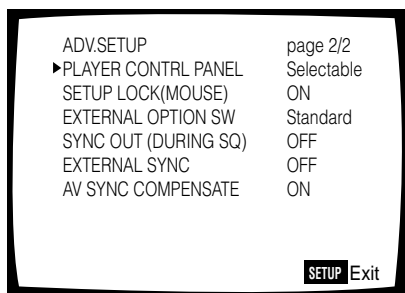
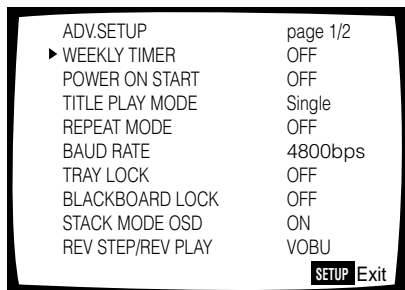

Above picture indicates the initial settings.

DVD Video CD CD

To access the ADV. SETUP menu

Press and hold **SETUP** for one second.

The screen displays the special menu shown in the figure on the left (hereafter called the ADV.SETUP menu).

To set a parameter, for example, the weekly timer, select **WEEKLY TIMER** with **▲ ▼**, setting ON/OFF, etc. with **◀ ▶**. If a parameter is set to ON, press **ENTER** and perform the setting instructions as prompted on the screen.

Likewise, for power-on start, select **POWER ON START** with **▲ ▼**, setting ON/OFF, etc. with **◀ ▶**. If a parameter is set to ON, press **ENTER**, set ON/OFF to ON and perform the setting instructions as prompted on the screen.

A similar procedure is used to set the other parameters with **▲ ▼** and set ON/OFF, etc. with **◀ ▶**.

In order to set up the unique functions of the DVD-V7300D, there are settings for 15 parameters that are made by the remote control unit.

① WEEKLY TIMER

The time for turning the power on and off can be set for each day of the week; moreover, the title and chapter where playback is to start can also be set. The player is limited to a maximum of 24 settings at one time. This function makes unmanned operation possible.

OFF: The WEEKLY TIMER function does not operate.

ON: The WEEKLY TIMER function operates.

② POWER ON START

This function sets whether or not automatic playback is to start when the power is switched on.

OFF: The POWER ON START function does not operate.

ON: The POWER ON START function operates. It is also necessary to set the playback title and chapter to identify the starting point for playback. If this starting point is not identified, the player waits in the playback stop status.

③ TITLE PLAY MODE

Single: When a single title has been selected in this mode, the DVD player stops when this one title has been played back.

All: When this mode has been selected, the player plays back each title on a DVD disc in turn until all have been played.

④ REPEAT MODE

Select OFF/CHAPTER/TITLE/DISC from the menu.

When TITLE PLAY MODE is set to ALL, DISC is selected.

OFF: The DVD player plays back in the normal status and does not repeat.

CHAPTER: One selected chapter only is repeated (DVD).
One selected track only is repeated (Video CD, CD).

TITLE: Playing back repeats only one title (DVD).

Playing back repeats the entire disc (Video CD, CD).

DISC: Playing back repeats the entire disc (DVD only).

⑤ BAUD RATE

This sets the baud rate of the RS-232C interface. Two baud rates of 4800 bps and 9600 bps can be selected.

⑥ TRAY LOCK

When set to ON, the opening and closing action of the disc tray is locked.

⑦ BLACKBOARD LOCK

When set to ON, entering the video blackboard input mode is prevented.

⑧ STACK MODE OSD

This controls ON/OFF switching of the OSD when executing a stack.

ON: The STACK display appears on the screen when executing a stack and when searching.

OFF: The STACK display does not appear on the screen.

ADV. SETUP MENU settings

⑨ REV STEP/REV PLAY

This selects the image units for reverse play.

VOBU: This depends on the disc being played back, but usually reverses in blocks of 0.4 - 1 second.

Frame: Reverses at intervals of one frame.

⑩ PLAYER CONTROL PANEL

This selects the display mode of the icon panel that can be controlled with a mouse.

Selectable: Press (click) the left and right buttons of the mouse simultaneously, or with the left button pressed, click the right button, and the icon control panel is displayed.

Always On: The icon control panel is always displayed. However, there are times when the panel will not be displayed due to the various setup screens.

Always Off: The icon control panel is not displayed.

⑪ SETUP LOCK (MOUSE)

This sets whether or not the SETUP or ADV.SETUP menu can be activated from the icon control panel.

ON: The SETUP or ADV.SETUP menu cannot be activated from the icon control panel.

OFF: When the SETUP button on the icon control panel is left-clicked with the mouse, the SETUP menu is activated, and when the ADV.SETUP button is left-clicked, the ADV.SETUP menu is activated.

⑫ EXTERNAL OPTION SW

This is used to set the key of the external option switch.

Standard: Input of all external option keys is possible.

Limit: Only the following input is possible among the external option keys:

Up/down/left/right cursor, ENTER, number keys 1-6, STACK GROUP 1-6, TOP MENU, and MENU

⑬ SYNC OUT (DURING SQ)

This function sets whether or not a video synchronization signal is output to a black screen or to a blue background when the player is not outputting video.

OFF: Video is always output (the synchronization signal remains).

ON: Video is not output at times other than during playback and during menu screen display.

⑭ EXTERNAL SYNC

This selects the synchronized TV signal format when external synchronization is input.

OFF: This setting prohibits the external synchronizing function.

PAL : When the DVD disc is to be played back in PAL format.

NTSC: When the DVD disc is to be played back in NTSC format

⑮ AV SYNC COMPENSATE

This is set when a method that uses external synchronization is used, when the player is used by itself, and when multiple units are operated side by side and the video frames are aligned.

ON: When using the player by itself

OFF: When multiple units are operated side by side and the video frames are aligned

Note

Setting below items can not be changed during playback. Operate them in the stop mode.

- REV STEP/REV PLAY
- EXTERNAL SYNC
- AV SYNC COMPENSATE

Player control using a mouse

Mouse operation is possible by connecting a PS/2 mouse and turning power ON.

DVD Video CD

Button Selection

You can use the mouse to select DVD Menu buttons and buttons displayed on the screen.

When the mark cursor is placed on a button, it changes to the hand mark. While the cursor is displayed as the hand mark, clicking on a button with the left button on the mouse lets you perform operations in the same way as with the remote control.

* Menu selection with the mouse is not possible with Video CDs.

DVD Video CD CD

Player control icon

Pressing the mouse's left and right button simultaneously or clicking the right button while holding the left button displays the player control icons on the bottom left of the screen. When the mouse pointer is placed on a player control icon, the pointer changes from the arrow to the hand. While the pointer is in the form of the hand, clicking with the left mouse button performs the same operation as the remote control unit button.

Function \ Discs	DVD	Video CD	CD
▶▶▶	YES	YES	YES
▶▶	YES	YES	YES
▶▶▶	YES	YES	NO
▶	YES	YES	YES
◀▶▶	YES	NO	NO
◀▶	YES	YES	YES
◀▶▶	YES	YES	YES
◀▶▶▶	YES	YES	NO
TOP MENU	YES	NO	NO
MENU	YES	NO	NO

• The buttons appearing in video images recorded on commercially available DVD video discs may not be located in the recognized positions. With such discs, please use the remote control unit instead of the mouse.

In the case of a DVD

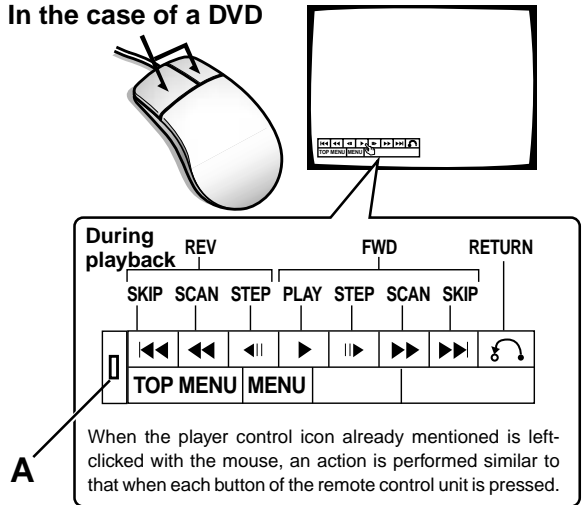

- When SETUP LOCK (MOUSE) on the ADV. SETUP menu is set to OFF, the SETUP and ADV. SETUP buttons appear on the player control panel. You can click these buttons with the mouse to enter the corresponding SETUP menu.
- When SETUP LOCK (MOUSE) is set to OFF and point "A" is dragged with the left mouse button held down, the location of the player control panel can be changed. Once the location is changed, the new location will be maintained until the power is turned off. The default panel position is restored when the power is turned off, then back on again. Initialization is also performed when the OSD position is changed and when the video blackboard is displayed.

NOTE

- The position of the player controls cannot be changed during playback of PAL discs.
- The position of the player control panel cannot be changed when the [OSD Position] in the SETUP MENU is set to [Wide] or when the video blackboard is displayed.

In the case of a Video CD

In case of left click, this unit works as the icon indicated. Video titles cannot be directly selected with a mouse. Right-clicking the player control icon, as in the figure, displays a number at the upper right of the screen, and pressing the [ENTER] the title of the number that has been input to be selected.

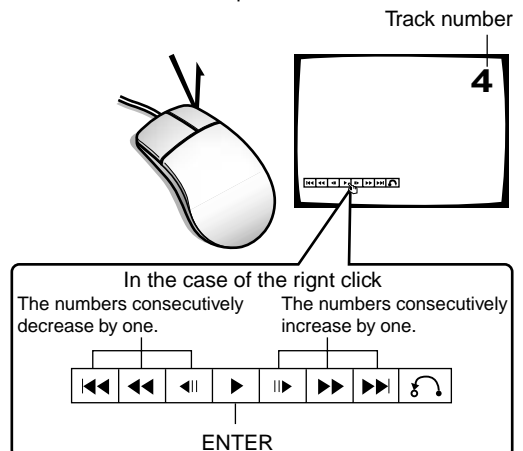

Note

If the title of the number that has been input is not present or mouse operation is prohibited, it cannot be executed.

Weekly timer function operation/display

1

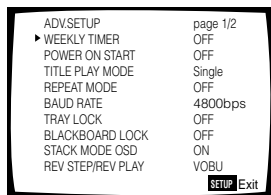

2

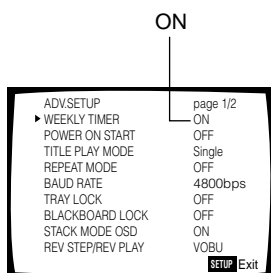

3-4

1/3 shows that there are three pages of setting, and that this screen is the first of these pages.

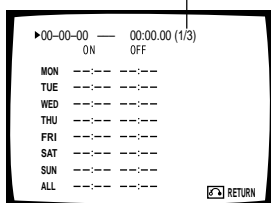

5

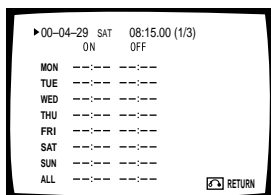

Note

- The internal clock has a tolerance of approximately ± 2 minutes per month. (The amount varies depending on the usage environment.)
- The built-in clock is powered by a capacitor. The clock of this unit functions even when it is in the STANDBY mode, provided that the AC cord is plugged into a power outlet. If the AC cord is unplugged, the clock can continue functioning for 7 to 10 days (when the capacitor is fully charged and at 25°C).
- Weekly timer setting is kept remembered as if AC cord is unplugged for long times.

DVD Video CD CD

Setting/correcting the current time

Set the current date and time.

1. Move the **▶** (pointer) to "WEEKLY TIMER" by pressing **▲** or **▼**.

2. Press **◀** or **▶** and set to ON.

3. Press **ENTER**.

- The Weekly Timer setting screen is displayed.

4. Press **ENTER**.

- The date/time setting screen is displayed blinking.

5. Set the time of the day.

- Set figures in order of year (2 digits), month, day, day of the week, hour, minute and second.

These figures can be input in any of the following two methods.

A. Input using the numeric buttons and **▶▶**

B. Input using **▲** or **▼** and **ENTER**

- "A" and "B" in the following description refers respectively to the two operation methods above.

Example) To set to 8:15:00, Saturday April 29, 2000

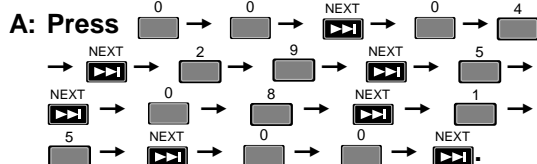

*The days of the week can be set using the following numeric buttons.

MON: 0, TUE: 1, WED: 2, THU: 3,
 FRI: 4, SAT: 5, SUN: 6.

B: Press the **▲** or **▼** to select 00 and press **ENTER** to start the setting of the next set of figures (the month in this case). Set the month, date, day of the week, hour, minute and second, and press **ENTER** to complete the setting operation.

To correct the date or time

When the setting screen appears in step 3 above, press **ENTER** so that the figures of the year start to blink. Then press **▶▶** 4 times so that the figures of hour blink, and set them with the same method as above.

Setting the weekly timer

1. When the setting screen appears in step 3 on the previous page, press or to move (pointer) to the day of the week and press **ENTER**.

- Power ON/OFF time setting display appears.

2. Set the power ON/OFF time.

Example 1) To turn power ON at 10:30 on Wednesday

- Move (pointer) to "WED" and press **ENTER**.

A: Press → → → → → → .

B: Press or to select 10 and press **ENTER** the item to set the setting of the next set of figures. Now Press or to set it to 30 and press **ENTER** twice.

- If the power OFF time is not set, the timer simply turns power ON.

Example 2) To turn power ON at 10:30 on Wednesday and turn it off at 17:45

A: Press → → → → → → → → → → → → .

B: Press or to select 10 and press **ENTER** item to set the setting of the next set of figures. Set the subsequent sets of figures to 30, 17 and 45 by repeating the above.

NOTE:

It is also possible to set only the power OFF time without setting the power ON time. In this case, when power is turned ON manually, it will be turned OFF at the set time.

- You can set the WEEKLY TIMER with the mouse as well as with the remote control.
- Where is displayed, clicking with the left mouse button lets you change selections or settings.
- Each time you click the left mouse button, the numerical value is increased by one, Each time you click the right button, the numerical value is decreased by one.

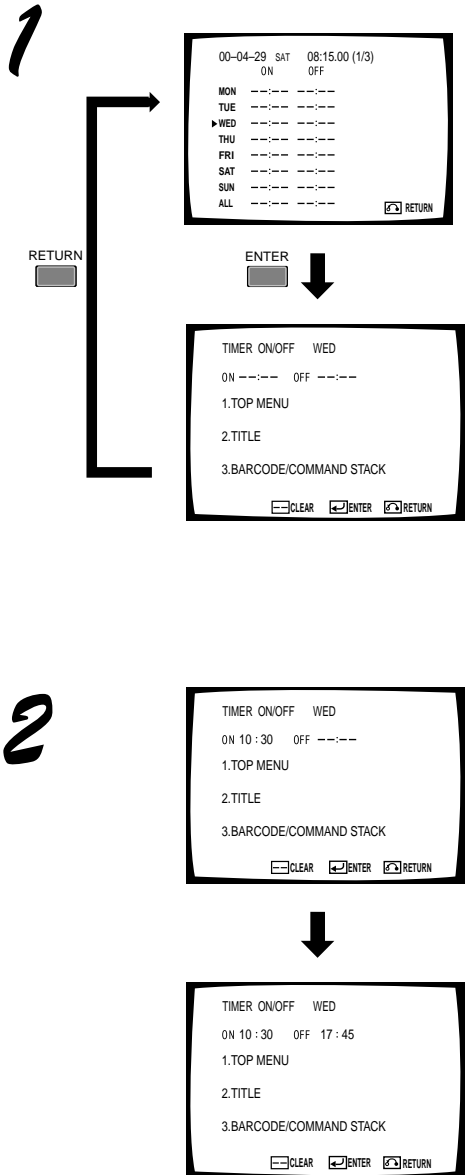

- Select **ENTER** on the screen to enter the setting and exit the screen. Select **RETURN** to cancel the setting and return to the previous screen.

Weekly timer function operation/display

3

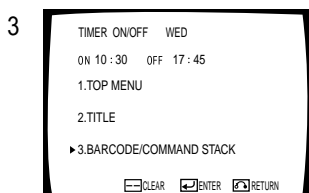
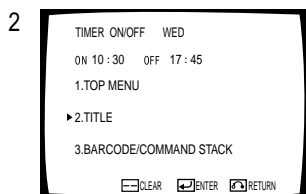
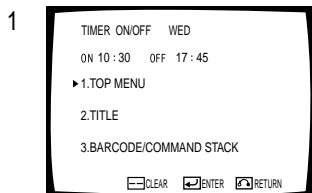

For your reference

Memorized data is not erased even if AC power cord is unplugged.

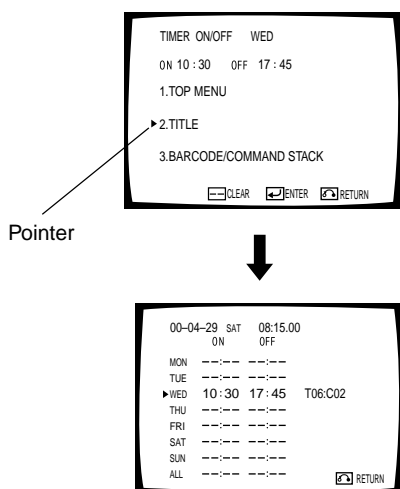

- Select ENTER on the screen to enter the setting and exit the screen. Select RETURN to cancel the setting and return to the previous screen.

3. Set the operation to be performed at the moment timer playback starts.

1. TOP MENU: Setup for playing from top of the menu.
2. TITLE: Setup for playing the specified title and chapter.
 - Refer to "Playing the specified title and chapter".
3. BARCODE/COMMAND STACK: Setup for recalling the display of the barcode command stack groups from memory.
 - Refer to "Setup for recalling the barcode/command stack groups from memory" (See page 53).
 - Select one of the above with or , and press



NOTE

- This step cannot be performed if the power ON time has not been set.
- The data is written in memory at the moment the timer setup screen is exited. The timer setup will not be stored in memory if power is turned off before or without exiting the screen.
- On a DVD disc that has been setup to start playback automatically, the setup made above will not be applied to the disc.

DVD Video CD CD

Clearing the set time

With the TIMER ON/OFF time input screen (shown left) displayed, press and then press of the remote control unit.

DVD Video CD CD

Playing the specified title and chapter

- Move (pointer) to "2 TITLE" and press .

Example) To begin playback with Chapter 2 of Title 6

A: Press → → → → → .

B: Press or to select 06 and press to start the setting of the next set of figures. Now press or to select 02 and press .

NOTE

- When a title and chapter are selected, playback continues after the selected chapter only when there is one or more chapter after it. Playback completes at the end of the selected title. If repeat playback is set in the ADV SETUP menu, the selected chapter is played first then the set repeat playback starts.
- When setting tracks on a CD or Video CD, please enter the track number in the CHAPTER in the above setting. At this time TITLE and BARCODE/COMMAND STACKS settings will not operate.

DVD Video CD CD

Setting to turn on player power only

When selecting a title, enter a title which is not on the disc.
Example: Enter title 99.

DVD

Setup for recalling the barcode/command stack groups from memory

• Move the pointer to 3. BARCODE/COMMAND STACK and press .

Example) To recall and execute Barcode/Command stack group "5"

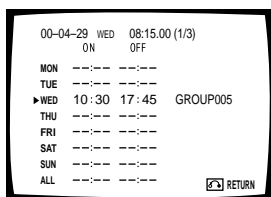
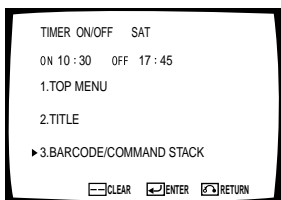

A: Press **→** .
B: Press or **to select 005 and press**
 .
 Now the timer setting is complete.

- Select ENTER on the screen to enter the setting and exit the screen. Select RETURN to cancel the setting and return to the previous screen.

NOTE

When a Barcode Command stack group is selected, the command stack within the group will be executed repeatedly regardless of whether the repeat mode in the ADV SETUP menu is set to ON or OFF.

DVD Video CD CD

Setting the timer function not to operate with the weekly timer setting left as is

1. Move the ▶ (pointer) to WEEKLY TIMER on the ADV SETUP menu screen with or and set to OFF with the remote control unit's or .

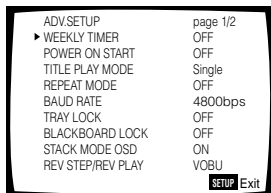

Weekly timer function operation/display

DVD Video CD CD

Setting the WEEKLY TIMER and Expandable Functions

You can change the day for the WEEKLY TIMER settings. This setting allows for the power to be turned on and off more than two times in the same day. In addition, with the ALL setting, the player can be set to turn on and off at the same time every day.

DVD Video CD CD

Setting the day for the WEEKLY TIMER



1. Select the WEEKLY TIMER setup screen.

- For information on how to select this screen, see page 50 and 51.

2. When the setting area below ON is blinking, press .

- The setting that indicates the day of the week will begin to blink.

3. Select a day by using or .

In step 3 above, as you press  or , the following 8 possible settings will be displayed: MON, TUE, WED, THU, FRI, SAT, SUN, and ALL. For information on how the WEEKLY TIMER operates when ALL is selected, see page 55.

4. Press .

- For information on how to turn the timer ON/OFF and other settings, see page 51.

You do not have to use the remote control, the mouse can be used as well. Position the cursor over the day setting and click the left mouse button to change the day.

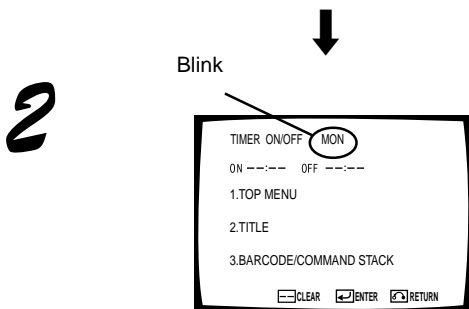
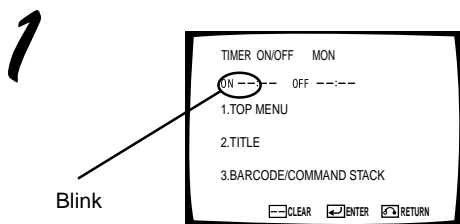

 or  ↓
Display changes MON ~ ALL

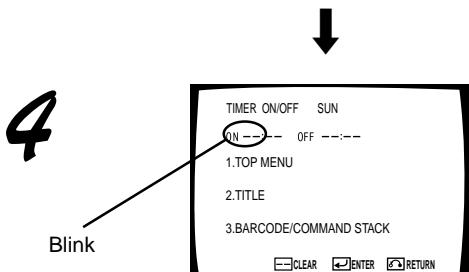
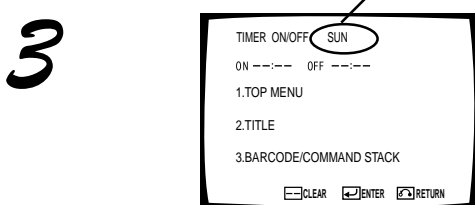

- Select ENTER on the screen to enter the setting and exit the screen. Select RETURN to cancel the setting and return to the previous screen.

DVD Video CD CD**Setting the power to turn on and off more than two times in the same day****Example 1)**

When set as seen in Example 1, the power turns on at 7:30 a.m. on Sunday and playback begins from the first title chapter (track) 1. Then the power turns off at 12:00 noon. At 1:00 p.m. on Sunday, the power turns on again and playback begins from the second title chapter (track) 1. The power then turns off at 5:30 p.m.

In this way, the player can be set the time to turn on and off a maximum of 24 times on the same day.

DVD Video CD CD**Setting the player to turn on and off at the same time every day****Example 2)**

Refer to page 54 while setting the day setting to ALL. After this is set, the time at which the player will turn on and off every day can be entered.

In Example 2, the power turns on everyday at 7:30 a.m. and playback begins from the first title chapter (track) 1. The power then turns off at 5:30 p.m.

Example 3)

As can be seen in example 2, if you want the power to turn on everyday except Sunday, set the time in the OFF column for Sunday exactly the same as the time for the ON column of ALL. Leave the time setting in the ON column for Sunday blank.

In Example 3, on Sunday the power is always off, while on the remaining days the power turns on at 7:30 a.m. and playback begins from the first title chapter (track) 1. The power then turns off at 5:30 p.m.

DVD Video CD CD**Setting the power to turn on and off in the other day****Example 4)**

As can be seen in example 4, the power turns on at 11:00 p.m. on Monday and turned off at 2:00 a.m. on Tuesday (Monday midnight).

Example 1)

00-04-29	SAT	08:15.00 (1/3)
	ON	OFF
MON	----	----
TUE	----	----
WED	----	----
THU	----	----
FRI	----	----
SUN	07:30	12:00 T01: C01
▶SUN	13:00	17:30 T02: C01
ALL	----	----

List display

Example 2)

00-04-29	SAT	08:15.00 (1/3)
	ON	OFF
MON	----	----
TUE	----	----
WED	----	----
THU	----	----
FRI	----	----
SAT	----	----
SUN	----	----
▶ALL	07:30	17:30 T01: C01

List display

Example 3)

00-04-29	SAT	08:15.00 (1/3)
	ON	OFF
MON	----	----
TUE	----	----
WED	----	----
THU	----	----
FRI	----	----
SAT	----	----
▶SUN	----	07:30
ALL	07:30	17:30 T01: C01

List display

Example 4)

00-04-29	SAT	08:15.00 (1/3)
	ON	OFF
MON	23:00	----
TUE	----	02:00
WED	----	----
THU	----	----
FRI	----	----
SAT	----	----
▶SUN	----	----
ALL	----	----

DVD Video CD CD

Examples of when the times set for the WEEKLY TIMER overlap

Example 5)
When the following settings are selected for the same day.

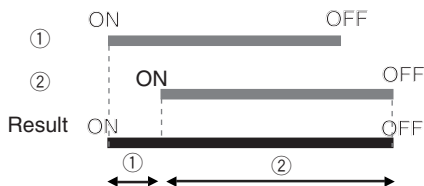

Example 6)
When the following settings are selected for the same day.

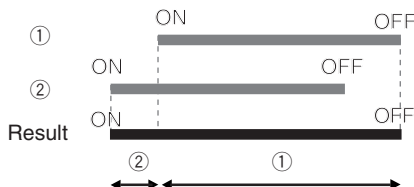

Example 7)
When the following settings are selected for the same day.

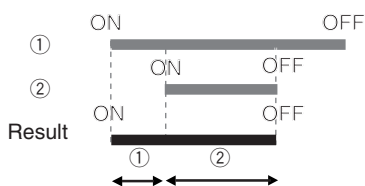

Example 8)
When the following settings are selected for the same day.

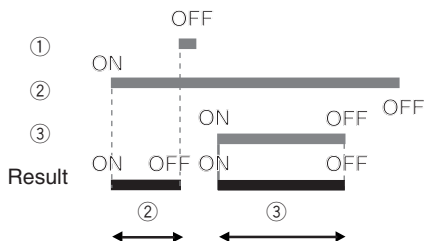

Example 9)
When the following settings are selected for ALL and SUN.
(The times set for ① ON and ② OFF are the same time.)

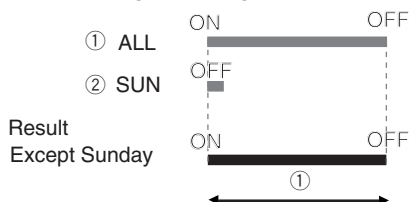

However when the ON time and the OFF times do overlap, please understand that the player will operate as indicated in the examples below.

Example 5)

In ①, the player begins to operate according to the time set for ON. Next, in ② the player begins to operate according to the time set for ON. In this case, the OFF setting for ① will be ignored, and the player will turn off at the time that was set for ②.

Example 6)

In ②, the player begins to operate according to the time set for ON. Next, in ① the player begins to operate according to the time set for ON. In this case, the OFF setting for ② will be ignored, and the player will turn off at the time that was set for ①.

Example 7)

In ①, the player begins to operate according to the time set for ON. Next, in ② the player begins to operate according to the time set for ON. In this case, the player will turn off at the time that was set for ②.

Example 8)

In ②, the player begins to operate according to the time set for ON. Next, in ① the player will turn off momentarily according to the time set for OFF. Then, in ③ the player begins to operate again at the time set for ON. Lastly, the player will turn off at the time that was set for ③.

Example 9)

In ① ALL (everyday), the player begins to operate according to the time set for ON except for Sunday. These settings result in the player turning on and off according to the times set for ON and OFF in ①. The player therefore will not operate on Sunday.

Notes

When the ON and OFF times are set to the same exact time, the player will react differently according to previously designated settings.

In Example 9, when the ON and OFF times are set the same, the power is OFF and the player is in standby up until that designated time.

When the ON and OFF times are set the same, in the case when the player is ON up until that time, the OFF time set for ② will be ignored.

Power on start function

1-2

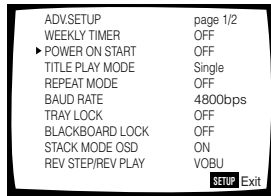

3

In the case of 1
 In the case of 2
 In the case of 3

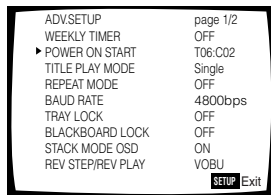
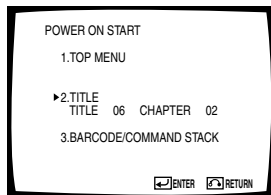
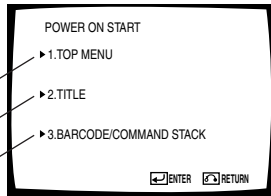

Selecting the special title and chapter

- Select ENTER on the screen to enter the setting and exit the screen. Select RETURN to cancel the setting and return to the previous screen.

DVD Video CD CD

Setting the power on start function

1. Move the ► (pointer) to "POWER ON START" by pressing ▲ or ▼.
2. Set it to ON by pressing ◀ or ▶.
3. Press ^{ENTER} [ENTER].

- The POWER ON START setting screen is displayed.

1.TOP MENU:

Playing from the top menu screen.

2.TITLE:

Playing the specified title and chapter.

3.BARCODE/COMMAND STACK:

Recalling and executing the Barcode/Command stack groups in memory.

- Select one of the above with ▲ or ▼, and press ^{ENTER} [ENTER].

1. Playing the top menu

- Move the ► (pointer) to 1. TOP MENU and press ^{ENTER} [ENTER].

2. Playing the specified title and chapter

- Move the ► (pointer) to 2. TITLE and press ^{ENTER} [ENTER].

Example) To begin playback with Chapter 2 of Title 6

A: Press [0] → [6] → [NEXT] → [0] → [2] → [NEXT].

B: Press ▲ or ▼ to select 06 and press ^{ENTER} [ENTER] item to start the setting of the next set of figures. Now press ▲ or ▼ to select 02 and press ^{ENTER} [ENTER].

NOTE

- When setting tracks on a CD or Video CD, please enter the track number in the CHAPTER in the above setting. At this time TITLE and BARCODE/COMMAND STACKS settings will not operate.

You can set the POWER ON START FUNCTION with the mouse as well as with the remote control.

- Where is displayed, clicking with the left mouse button lets you change selections or settings.
- Each time you click on a number with the left mouse button, it increases by 1. Each time you click on a number with the right mouse button, it decreases by 1.

Power on start function

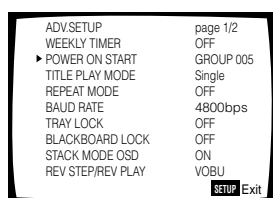
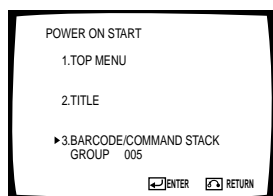

Setting the Barcode/Command stack

- Select ENTER on the screen to enter the setting and exit the screen. Select RETURN to cancel the setting and return to the previous screen.

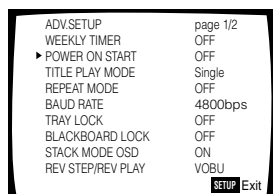

For your reference

Memorized data is not erased even if AC power cord is unplugged.

3. Recalling and executing the Barcode/Command stack groups in memory

- Move the ► (pointer) to 3. BARCODE/COMMAND STACK and press .

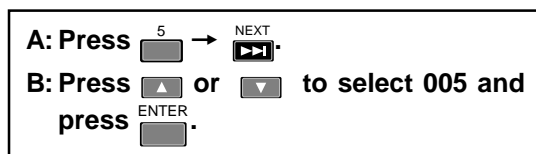

Example) To execute Barcode/Command stack group 5

- The ADV SETUP menu setup screen is displayed again, in which the **POWER ON START** setting is shown. Now the setting of the operation to be performed at power ON is complete.

NOTE

With a disc with which playback starts automatically, the operation may differ from the setting.

DVD Video CD CD

Setting to turn on player power only

When selecting a title, enter a title which is not on the disc.

Example: Enter title 99.

DVD Video CD CD

Turning off the POWER ON START FUNCTION

1. On the ADV SETUP menu screen, move the ► (pointer) to **POWER ON START** with the remote control unit's or and select **OFF** with the remote control unit's or .

Setting is possible by the mouse instead of the remote control. When the ► pointer is on MENU, click left button, ADV. SETUP menu is disappeared.

Barcode/Command stack function

This player can be used as follows using the Barcode stack/Command stack function

- Commands in the barcode book included with the disc can be memorized in the player in advance. (Barcode stack function.)
- Barcodes can be set using the provided remote control for discs that do not have barcodes, or for commands that you want to use that are not provided with barcodes. (Command stack function.)
- The remote control can be used for recall and successive execution or step by step execution of memorized content.

NOTE:

The Barcode stack/Command stack function will not operate with CD or Video CDs.

NOTE:

- The maximum number of steps that can be memorized in the player is 300 steps including video blackboards.
- Memorized data is not erased even if power to the unit is switched OFF.Barcode/Command screen

DVD

Basic usage

How to use the barcode stack/command stack function is indicated as follows:

Details of those settings, refer to the pages after "→".

- 1. Display the barcode stack/command stack setup screen with the remote control**
→ Page 60
- 2. Input the barcode with the barcode reader and transmit to player** → Page 61
 - Input can also be done with the remote control unit.
→ Page 60-64
- 3. Repeat step 2 in the desired playback order.**
- 4. When input is finished, store in the player's memory** → Page 65
- 5. Execution** → Page 74, 75

DVD

Advanced usage

With the barcode stack/command stack function of this unit, groups can be divided and memorized without influencing previously input commands.

This is convenient for separate memorization of contents of more than one disc, or when one player is being jointly used by many people.

To register a group separate to the already previously memorized content

1. Register a new group → Page 67

"GROUP 002" on the top right of the barcode stack/command stack input screen is the group number that will be memorized.

As the group number will be important for execution, please make a note of it so that you do not forget it.

2. Input the barcode with the barcode reader and transmit to player → Page 61

- Input can also be done with the remote control unit.
→ Page 60-64

3. Repeat step 2 in the desired playback order.

4. When input is finished, store in the player's memory → Page 65

5. Execution → Page 74, 75

At this time please select the group number that was noted in step 1.

NOTE:

Commands stored in the player's memory can be grouped together or divided → Page 70-73.

Please note, however, that the order of commands can not be changed.

Barcode/Command stack setting

Barcode/Command screen

1

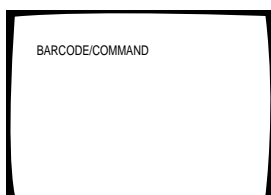

2

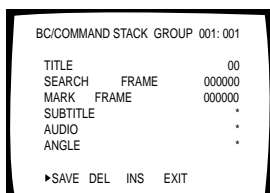
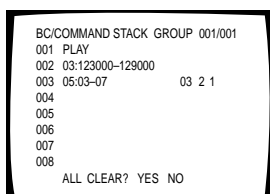

The player can store commands input using LASERBARCORD and DVD barcodes. The stored commands can be recalled for either successive or step-by-step execution.

Memorized data is not erased even if AC power cord is Unplugged.

DVD

Displaying the Barcode/Command stack screen







1. Press ^{MEMORY} .

- "BARCODE/COMMAND" is displayed.

NOTE

The system cannot enter this mode during display of the player control panel.

2. Press ^{ENTER} .

- The Barcode/Command Stack screen is displayed.
- If barcodes have already been input, their data are shown in the screen.
Select whether barcodes are to be input by erasing existing barcodes or by adding them to the existing barcodes.
- To input new barcodes from the beginning, select "YES" with  or  and press ^{ENTER} .
- To add new barcodes to existing barcodes, select "NO" with  or  and press ^{ENTER} .
- Press ^{ENTER}  to display the Barcode/Command Stack Input screen.
- When barcodes have not been input, the Barcode/Command Stack input screen will be displayed.

- The setting procedure of this screen will be described in the subsequent pages.
- Barcode/Command Stacks can be set directly using a barcode reader (optional) or set using the remote control unit.

1

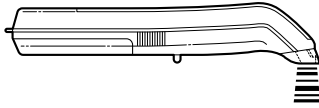

DVD

Direct setting using a barcode reader

1. Read a barcode with a barcode reader.
2. Send it to the player.

Example 1) Read "PLAY" and send it.

Example 2) Read "Play Title 8 Chapters 5 to 12 with Subtitle 3, Audio 2 and Angle 1" and send it.

DVD

Setting using the remote control unit

Five commands including Play ►, Pause ■, ◀ Still/Step ▶ and Stop ■ and WAIT and GO TO GROUP can be set using the remote control unit.

The chapter search, chapter play, frame search and frame segment play* commands can also be set using the remote control unit.

* Frame segment play is to play between two specific frames.

Press .

- The TITLE number will blink and the input mode will be selected.

Example 1) To set "Play"

Press .

- The Barcode/Command Stack Input screen shows "PLAY" and increments to the next Input screen.

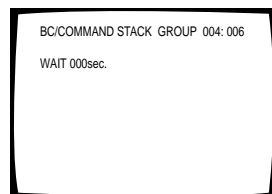
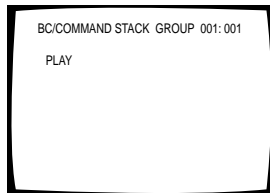

Example 2) enter the wait time

1. Press and hold .

- "WAIT 000 sec" appears on the screen.

2. Use the number buttons to enter the wait time in seconds.

- The maximum time value that can be entered is 999

3. Press .

(completes the procedures)

Barcode/Command stack setting

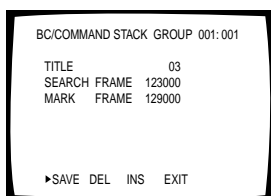

Display when the example on the right is input

Note

The difference between search frames and mark frames cannot be set to 24 frames or less. The entry must be 25 frames or greater.

Example 3) To "Play Title 3 Frames 123000 to 129000"

1. Press .
 - The TITLE number will blink.
2. Press → .
 - Title 3 is set, and the mode switches to Frame Input.
3. Press → → → → → → .
 - This sets the start frame number.
 - If the operation up to the present has been performed during playback, the input start frame is searched now.
4. Press → → → → → → .
 - This sets the end frame number.
 - If the operation in steps 3 and 4 is performed during playback, you can press in place of specifying the frame number in steps 3 and 4 above. In this case, the frame number being played is input automatically.

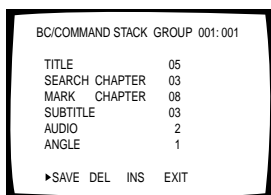

Display when the example on the right is input

Example 4) To "Play Title 5 Chapters 3 to 7 with Subtitle 3, Audio 2 and Angle 1"

1. Press .
 - The TITLE number will blink.
2. Press → .
 - This sets title 5 and the chapter input mode starts.
3. Press to select **SEARCH CHAPTER**.
 - This item sets the chapter number where playback should start.
 - Each press switches "CHAPTER" and "FRAME" alternately.
4. Press → .
 - This sets the start chapter number.
5. Press → .
 - This sets the end chapter number.
6. Press → .
 - This sets Subtitle 3.
7. Press . (Do not press .)
 - This sets Audio 2.
8. Press . (Do not press .)
 - This sets Angle 1. Now go to the next step.

For your reference

To play chapter 7 till the end as shown in Example 4), enter "8", obtained by adding 1 to 7, in MARK CHAPTER.

Item display

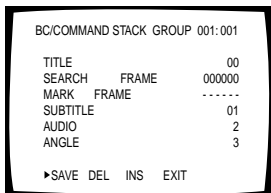

Press **DISPLAY** switches over to the following display

List display

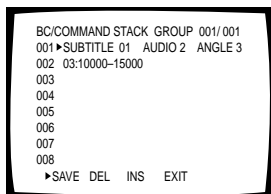

Example 5) To input the command for setting Subtitle 1, Audio 2 and Angle 3

1. When the word **TITLE** is blinking, enter “00” in the **TITLE**.
 - (Do not press **NEXT**).
2. Press **SUBTITLE** while the **TITLE** digits are blinking.
3. When the **SUBTITLE** digits start to blink, press **1** then **NEXT**.
4. When the **AUDIO** digit starts to blink, press **2**.
5. When the **ANGLE** digital starts to blink, press **3**.

• With a play command that specifies the start and end frames, it is not possible to set the subtitle, audio and angle simultaneously. However, by placing the subtitle, audio and angle setting command as described above before the frame section play command, the section playback can be executed with the specified setting.

The input as shown above allows to play title 3 frames 10000 to 15000 by setting Subtitle 1, Audio 2 and Angle 3.

With commands other than the frame section play command, such as the frame search, chapter search and chapter section play commands, the specified setting is valid within each command.

1.

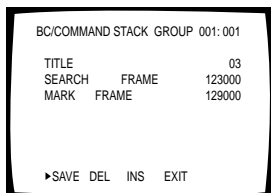

2.

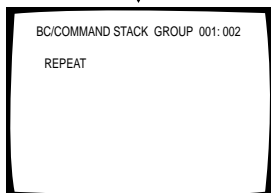
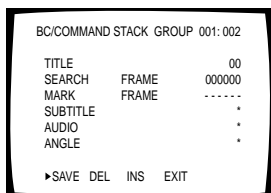



Example 6) To repeat “Play Title 3 frames 123000 to 129000” in Example 3

1. Perform steps 1 to 4 in Example 3.
 - The barcode/command stack input screen of the next step appears.
2. Press **RPT A-B** while the **TITLE** number is blinking.
 - The REPEAT indicator appears on the screen.

Barcode/Command stack setting

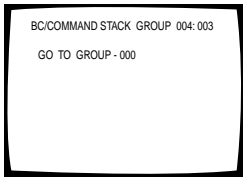
Example 7) Inputting a command to jump to another group.



1. When the **TITLE** number is flashing, press **RECALL** .
2. The display changes to that indicated in the figure on the left. Input the number of the group you want to jump to, and press **NEXT** .

To change a previously input "GO TO GROUP" command group number, press **RECALL**  during Detailed or List display, and input the new number.

Using this command enables consecutive jumping to different groups.

< Conceptual representation >

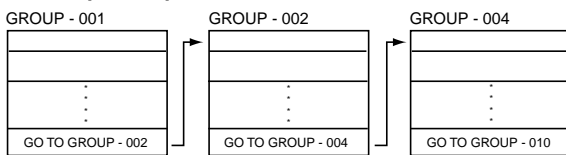

You can also create standby display groups. If you do this, you return to the standby display after jumping to another group.

< Conceptual representation >

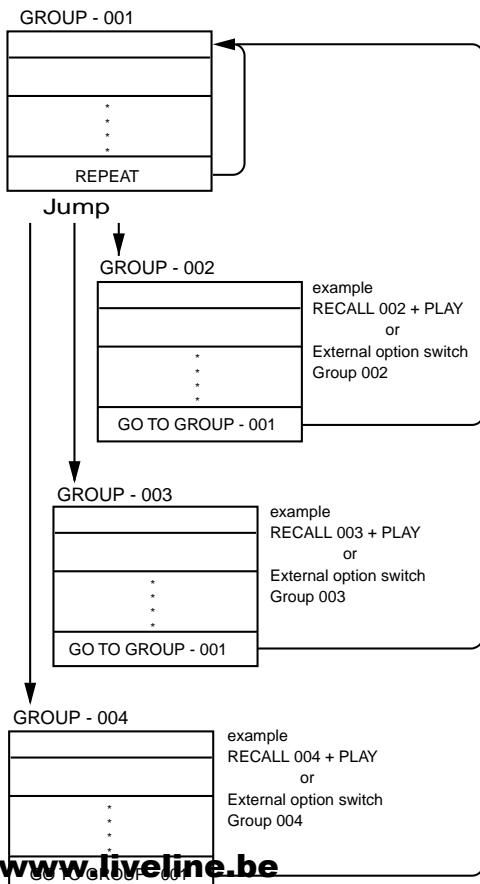

DVD

Setting the Subtitle, Audio and Angle

SUBTITLE

- "00" turns the screen color to the color specified in "Background color" in the GUI menu and makes the played image invisible.
- "01" to "32" displays the corresponding subtitle.
- "33" plays with Subtitle OFF.
- "34" is used to make the played image made invisible with "00" visible again.
- "99" retains the previous condition. This is used to change other setting than SUBTITLE while maintaining the SUBTITLE setting the same.
- "35" to "98" are invalid.

AUDIO

- "0" plays image with Audio OFF.
- "1" to "8" selects and plays the corresponding audio.
- "9" retains the previous condition.

ANGLE

- "1" to "8" selects and plays the corresponding angle.
- "9" retains the previous condition.
- "0" selects and plays Angle 9.

NOTE

- When "retain the previous condition" is selected, "*" is displayed in the input screen.
- The barcode/command stack cannot be executed if a value that does not exist in the disc is input.

DVD

To use only the chapter search or frame search

In item "MARK CHAPTER" or "MARK FRAME", simply press

NEXT  without setting anything.

A still image is displayed after search.

DVD

To change a value during input



Press the numeric button of the correct number (including 0).

To return to a previous setting point, press **PREV** .

DVD

To cancel input in the middle

Move the  (pointer) to "EXIT" by pressing the cursor button

 (right direction) and press **ENTER** .

DVD

Saving Barcode/ Command stack

When input has been completed to the end using the example operation, the barcode stack/command stack input screen for the next step appears in a few seconds.

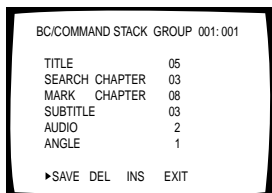

When this screen appears, press or to move (pointer) to **SAVE** and press .

- The display disappears and the input information is saved.

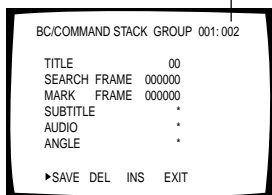

The display disappears.

NOTES:

- The input information is not saved if (pointer) is moved to **SAVE** and is pressed before the bar code stack/command stack input screen for the next step appears.
- The input information is not saved if (pointer) is moved to **EXIT** and is pressed.

DVD

To delete a previously input Barcode/ Command stack

1. Press .

- “BARCODE/COMMAND” is displayed.

2. Press .

- The Barcode/Command Stack screen is displayed.

3. Select “NO” with or and press .

- The Barcode/Command Stack Input screen is displayed when is pressed.

4. Press .

- The list display appears.

5. Move the (pointer) to “DEL” by pressing the cursor button (right direction).

6. Select the step to be deleted by pressing

or .

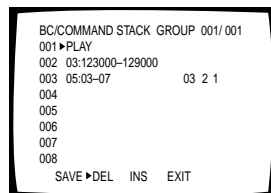

7. Press .

- The selected step is deleted and the numbers of the subsequent steps are decremented by 1.

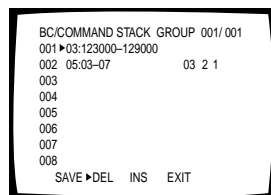

8. Move the (pointer) to “SAVE” by pressing

and press .

IMPORTANT:

Even if you have come to step 7 in the above deletion procedure, you can still abort deletion by moving the (pointer) to “EXIT” by pressing the cursor button (right direction) then pressing . The deletion is entered in memory when the “SAVE” operation is performed in step 8.

Barcode/Command stack setting

DVD

Correcting a previously input Barcode/Command Stack

Example) To change the Audio setting of step 003 from 2 to 1

1. Press .
 - "BARCODE/COMMAND" is displayed.
2. Press .
 - The Barcode/Command Stack screen is displayed.
3. Select "NO" with or and press .
 - The Barcode/Command Stack Input screen is displayed when is pressed.
4. Press .
 - The list display appears.
5. Select "003 ▶" by pressing or .
6. Press .
 - This initiates the Barcode/Command Stack input mode.

```
BC/COMMAND STACK GROUP 001:003
TITLE          05
SEARCH CHAPTER 03
MARK CHAPTER   05
SUBTITLE       03
AUDIO          2
ANGLE          1
▶SAVE DEL INS EXIT
```

7. Press 4 times to select item "AUDIO".

8. Press .

```
BC/COMMAND STACK GROUP 001:003
TITLE          05
SEARCH CHAPTER 03
MARK CHAPTER   05
SUBTITLE       03
AUDIO          1
ANGLE          1
▶SAVE DEL INS EXIT
```

9. Press .

- The next step's Barcode/Command Input screen is displayed.

10. Move the ▶ (pointer) to "SAVE" by pressing

and press www.ineline.be

NOTE:

To save the corrected information, press repeatedly until the last item flashes (ANGLE in this example).

Press one more time to move to the page for the next step.

In this "next step", move ▶ (pointer) to SAVE and press to save data.

The corrected information is not saved if ▶ (pointer) is moved to SAVE and is pressed before the end of correction (in the middle of the step being corrected).

DVD

Adding a step in a previously input Barcode/Command Stack

1. Perform steps 1 to 4 of "Correcting a previously input Barcode/Command Stack".
2. Select the step where a new step is to be inserted by pressing or .
3. Move the ▶ (pointer) to "INS" by pressing or and press .
 - This inserts a new step before the selected step and the numbers of subsequent steps are incremented by 1.

```
BC/COMMAND STACK GROUP 001:001
001 PLAY
002 ▶
003 03:123000-129000
004 05:03-07 03 2 1
005
006
007
008
SAVE DEL ▶INS EXIT
```

4. Press .

- This initiates the Barcode/Command Stack input mode.

5. Set a step in the same way as "Setting a Barcode/Command Stack settings". (See page 61- 64)

6. Move the ▶ (pointer) to "SAVE" by pressing

and press .

Grouping some Barcode/Command Stacks

1



2

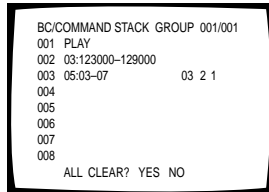

3

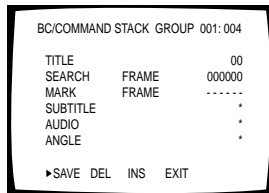

4

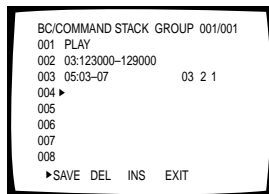

5

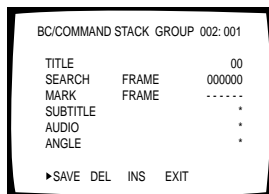

DVD

Methods of Grouping

Grouping some Barcode/Command Stacks

A group can be formed with several Barcode/Command Stacks, and more than one group can be formed and stored. When executing a group of commands, select a group from the stored groups and execute them either consecutively or step by step. It is also possible to divide or delete a group.

The following procedure consists of inserting a group delimiter after a group of barcode commands.

Inserting a group

1. Press .

- "BARCODE/COMMAND" is displayed.

2. Press .

- The Barcode/Command Stack screen is displayed.

3. Select "NO" with or and press the

.

- The Barcode/Command Stack Input screen is displayed when the is pressed.

4. Press .

- The list display appears.
- Make sure that the ▶ (pointer) is located at the step immediately following the last entry.

5. Press .

- The input screen for the first step of the next Barcode/Command Stack group appears.
- The Barcode/Command Stacks of the next group can be set from here.

Grouping some Barcode/Command Stacks

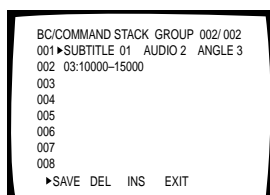
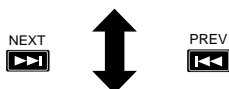
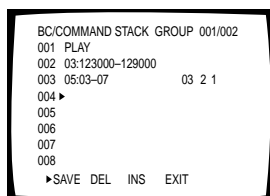

1

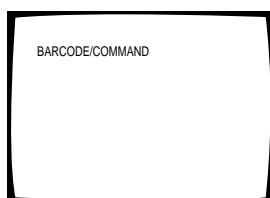

2

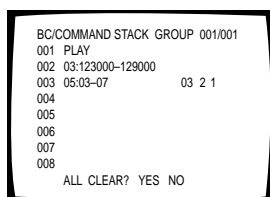

3

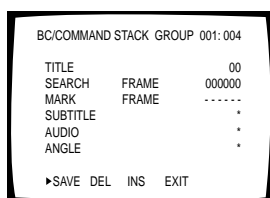

DVD

Switching the Barcode/Command Stack group

1. Press **MEMORY**.

- “BARCODE/COMMAND” is displayed.

2. Press **ENTER**.

- The Barcode/Command Stack screen is displayed.

3. Select “NO” with **◀** or **▶** and press the



- The Barcode Input screen is displayed when the button is pressed.

4. Press **DISPLAY**.

- The list display appears.

5. Press **PREV** **NEXT**.

- Pressing **NEXT** switches over to the next group.
- Pressing **PREV** switches over to the previous group.

DVD

Deleting a group

1. Press **MEMORY**.

- “BARCODE/COMMAND” is displayed.

2. Press **ENTER**.

- The Barcode/Command Stack screen is displayed.

3. Select “NO” with **◀** or **▶** and press **ENTER**.

- The Barcode Input screen is displayed when **ENTER** is pressed.

4

```

BC/COMMAND STACK GROUP 001/001
001 PLAY
002 03:123000-129000
003 05:03-07      03 2 1
004 ▶
005
006
007
008
▶SAVE DEL INS EXIT

```

4. Press ^{DISPLAY} .

- The list display appears.

5

```

BC/COMMAND STACK GROUP 001/001
001▶PLAY
002 03:123000-129000
003 05:03-07      03 2 1
004
005
006
007
008
▶SAVE DEL INS EXIT

```

5. Select the group to be deleted by pressing



6

```

BC/COMMAND STACK▶GROUP 001/001
001 PLAY
002 03:123000-129000
003 05:03-07      03 2 1
004
005
006
007
008
▶SAVE DEL INS EXIT

```

6. Move the ▶ (pointer) to “GROUP” on the first line by pressing .

7-8

```

BC/COMMAND STACK GROUP 001/001
001▶
002
003
004
005
006
007
008
SAVE▶DEL INS EXIT

```

7. Move the ▶ (pointer) to “DEL” by pressing the cursor button  (right direction).

8. Press ^{ENTER} .

- This deletes the selected group.

9



```

BC/COMMAND STACK GROUP 001/001
001▶
002
003
004
005
006
007
008
▶SAVE DEL INS EXIT

```

9. Move the ▶ (pointer) to “SAVE” by pressing the cursor button  (right direction) and press ^{ENTER} .

IMPORTANT

Even if you have come to step 8 in the above deletion procedure, you can still abort deletion by moving the ▶ (pointer) to “EXIT” by pressing the cursor button  (right direction) then pressing ^{ENTER} . The deletion is entered in memory when the “SAVE” operation is performed in step 9.

Grouping some Barcode/Command Stacks

1

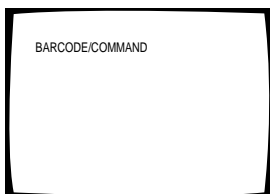

DVD

Dividing a previously input group

1. Press **MEMORY**.

- "BARCODE/COMMAND" is displayed.

2

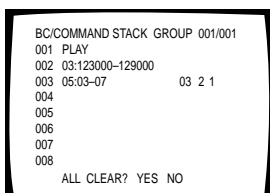

2. Press **ENTER**.

- The Barcode/Command Stack screen is displayed.

3

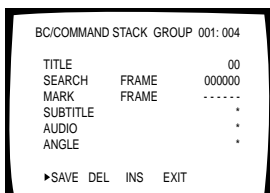

3. Select "NO" with **◀** or **▶** and press **ENTER**.

- The Barcode/Command Stack Input screen is displayed when **ENTER** is pressed.

4

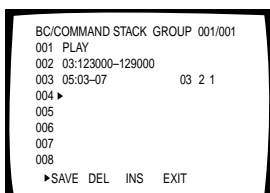

4. Press **DISPLAY**.

- The list display appears.

5

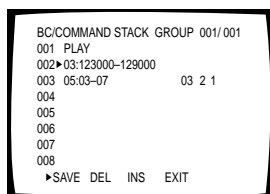

5. Select the step where the existing group is to be divided by pressing **▶** or **▼**.

- Move the ▶ (pointer) the first step of the group created by division.

6

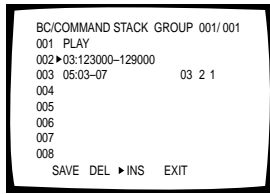

6. Move the ► (pointer) to “INS” by pressing

◀ or ▶.

7

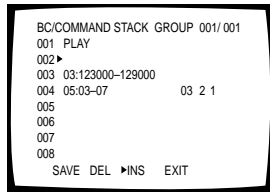

7. Press ^{ENTER} [ENTER].

- This inserts a vacant step before the selected step and the numbers of subsequent steps are incremented by 1.

8

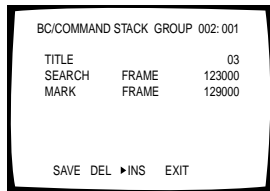

8. Press ^{NEXT} [NEXT].

- This divides the existing group at the vacant step.
- A new group is created. The Barcode/Command Stack Input screen of the first step of the newly created group is displayed.

9

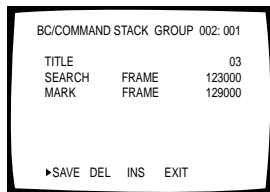

9. Move the ► (pointer) to “SAVE” by pressing the cursor but-

ton ▶ (right direction) and press ^{ENTER} [ENTER].

IMPORTANT

Even if you have come to step 8 in the above group procedure, you can still abort group by moving the ► (pointer) to “EXIT” by pressing ◀ then pressing ^{ENTER} [ENTER]. The group is entered in memory when the “SAVE” operation is performed in step 9.

Grouping some Barcode/Command Stacks

1

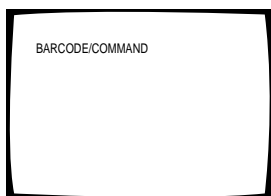

2

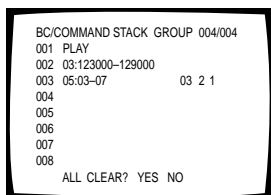

3

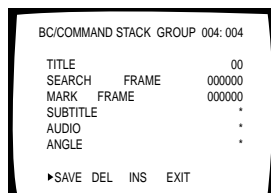

4

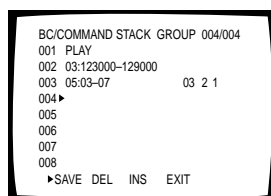

5

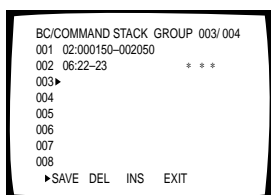

DVD

Joining two Barcode/Command Stack groups

1. Press .

- "BARCODE/COMMAND" is displayed.

2. Press .

- The Barcode/Command Stack screen is displayed.

3. Select "NO" with or and press .

- The Barcode/Command Stack Input screen is displayed when is pressed.

4. Press .

- The list display of the last group that was input is displayed.

5. Change the group with .

- Move the ▶ (pointer) to the next step of the previously input number with or . This becomes the division point.

6

```

BC/COMMAND STACK GROUP 003/004
001 02:000150-002050
002 06:22-23      * * *
003▶
004
005
006
007
008
SAVE▶DEL  INS  EXIT

```

6. Move the ▶ (pointer) to “DEL” by pressing the cursor button  (right direction).

7

```

BC/COMMAND STACK GROUP 003/003
001 02:000150-002050
002 06:22-23      * * *
003▶PLAY
004 03:123000-129000
005 05:03-07      03 2 1
006
007
008
SAVE▶DEL  INS  EXIT

```

7. Press .

- This deletes the group delimiter and joins the current group with the next group to it.
- The numbers of the groups after the current group are decremented by 1.

8



```

BC/COMMAND STACK GROUP 003/003
001 02:000150-002050
002 06:22-23      * * *
003▶PLAY
004 03:123000-129000
005 05:03-07      03 2 1
006
007
008
▶SAVE DEL  INS  EXIT

```

8. Move the ▶ (pointer) to “SAVE” by pressing the cursor button  (right direction) and press .

IMPORTANT

Even if you have come to step 7 in the above group Joining, you can still abort group by moving the ▶ (pointer) to “EXIT” by pressing the cursor button  (right direction) then pressing . The group is entered in memory when the SAVE” operation is performed in step 8.

Using a Barcode/Command Stacks

Switching the command group

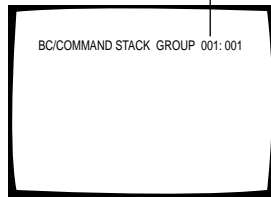

Recall screen

Switching the command step

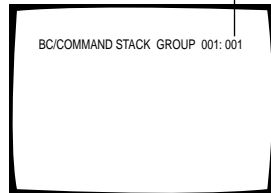



Recall screen

DVD

Recalling/executing barcode commands in memory





To execute a barcode command group:

Load the disc to execute them.





1. Press .
2. Press .
3. Input the number of the command group to be recalled/executed using the numeric buttons.
4. Press  twice.
 - This recalls and executes the selected group.

To execute steps in a command group:

Load the disc to execute them.

1. Press .
2. Press .
3. Input the number of the command group to be recalled/executed using the numeric buttons.
4. Press .
 - To re-enter the group number, press .
5. Input the number of the step to begin execution using the numeric buttons.
6. Press .
 - This recalls and executes the selected and subsequent steps in the selected group.

NOTES:

- Pressing  repeats the execution of the set GROUP.
- If you press  in place of  in step 6 above, command steps will be executed step by step. After one step has been executed, press  to advance to the next step. Pressing  allows you to return to the previous step.

NOTE

The system cannot enter this mode during display of the player control panel.

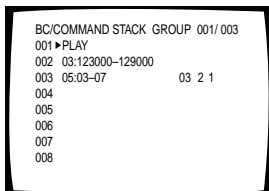

DVD

Recalling/executing previously input barcode/command stack from the list view

1. Press .

2. Press .

- This displays a list of commands.



3. Select a group by pressing  .

- Select the command group containing the command(s) to be executed.

4. Select a step by pressing  .

- Select the command step to begin execution with. If the command step number is left to "001" on this step, the commands in the entire command group will be executed.

5. Press  or .

- Pressing  starts consecutive execution.
- Pressing  starts step-by-step execution.

Some titles may not be able to be recalled and executed.

Example)

The search command cannot be executed with a title that does not show the chapter, time and similar information on the screen or with a disc that is not permitted to use the search function.

Character Input/Output drawing (DVD video blackboard)

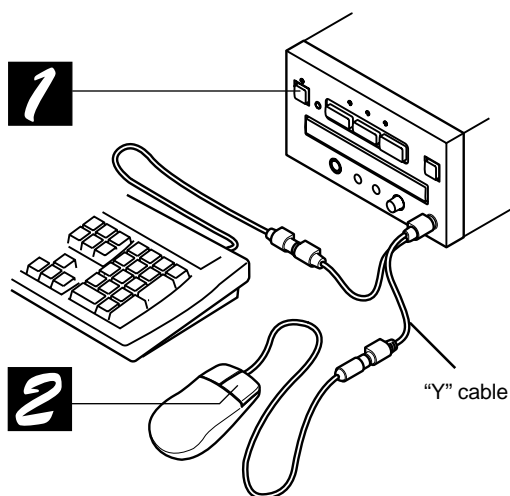

1-3

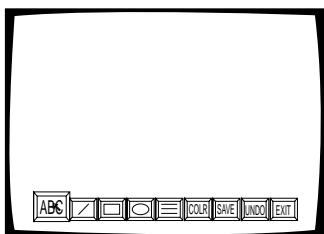

The video blackboard function of this unit allows you to draw characters and pictures just like on a blackboard. The drawn characters and pictures can be displayed alone or superimposed on the disc video.

DVD

Operation using the mouse or keyboard

Connect the PS/2 mouse or PS/2 keyboard to the mouse/keyboard connector of this unit. (See page 84)

DVD

Activating the blackboard function

- 1 Turn the power on.
- 2 Click the right button anytime to display the Blackboard screen.

Blackboard screen

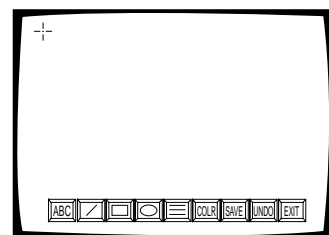
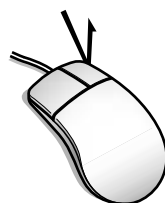

DVD

Inputting characters

4

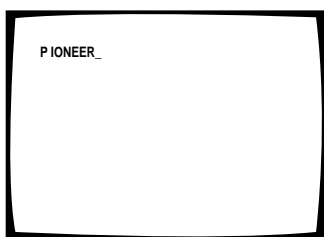

Input "PIONEER"

1. Move the cursor to  and click the mouse's left button.
2. Move the cursor to the position where you want to input the first character.
 - The cursor changes to the I cursor in the area where character input is possible.

5

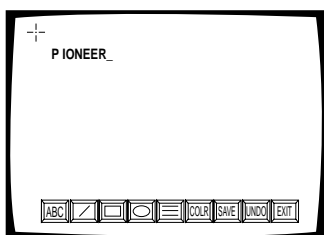

3. Click the mouse's left button.
 - " " brinks. You can input a character from this point.
4. Input a character.
 - Characters can also be input from the PC keyboard provided that this is connected.

The PC keyboard can input characters by distinguishing the numerals, symbols and uppercase/lowercase alphabet as well as carriage returns.
5. Click the mouse's right button after completing the input.
 - The Blackboard screen is displayed again.
 - To save the characters, use the procedure in "Saving characters or pictures" on page 78.

NOTE

The system cannot enter this mode during display of the player control panel.

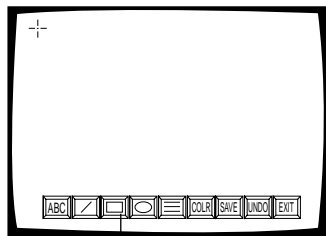

Drawing tool

1

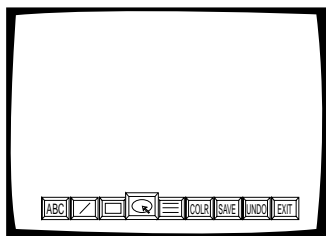

2

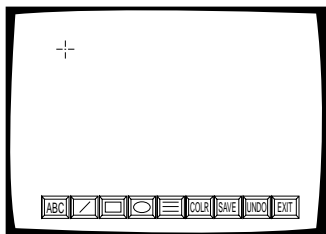

3

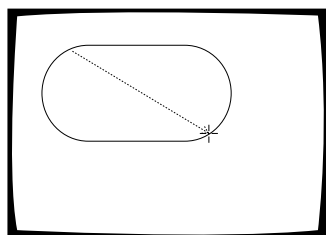

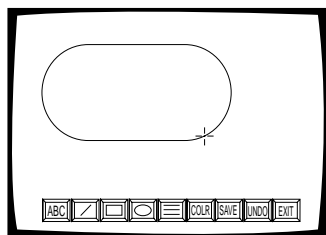

4









DVD



Using the drawing tools

- Use the mouse's left button to select icon below.





-  **(LINE):** Draws a straight line.
-  **(BOX):** This tool can be switched by clicking to a tool for drawing a line-enclosed rectangle, solid-painted rectangle or a rectangle the outside of which is painted.

-  : Paints in inside.
-  : Paints in outside.
-  **(ROUND):** This tool can be switched by clicking to a tool for drawing an ellipse, solid-painted ellipse or an ellipse the outside of which is painted.

-  : Paints in inside.
-  : Paints in outside.
-  : This tool can be switched by clicking to a tool for drawing a thin, medium or thick line.
-  **(COLOR):** Each click switches the color to Red, Blue, Green, Yellow, White, Black, Gray or Purple.

-  **(SAVE):** Saves the drawn picture.
(See page 78 for the saving method.)
-  **(UNDO):** Cancels the drawn picture. Each click cancels the last drawn picture.
Press with the mouse for more than 1 second to clear the entire drawing in the screen.
-  **(EXIT):** Click the mouse to exits the current screen .

NOTE

- The Direction buttons (   ) and  on the remote control unit can also be used for the above operation.
- The blackboard function will not function in a disc's menu screen.

DVD

Drawing a picture

Press the mouse's left button at the point you want to start drawing and move the cursor (without releasing the mouse button). (This operation is referred to as dragging.)

- 1. Select a drawing tool.**
- 2. Move cursor to the drawing start position.**
- 3. Drag.**
 - A picture is drawn as you move the cursor.
- 4. Release finger from the mouse.**
 - Draw other pictures by repeating the above.

Character Input/Output drawing (DVD video blackboard)

1

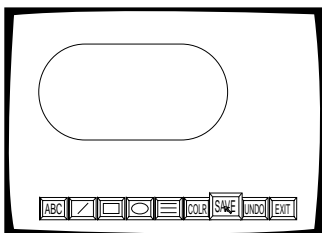

2-4

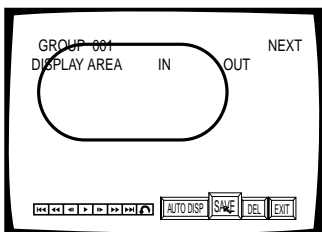

5

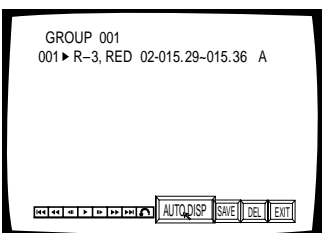

6

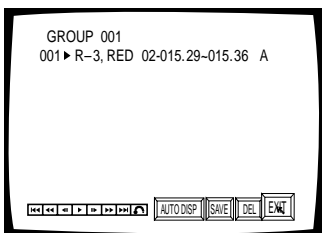

DVD

Saving characters or pictures

1. Click **SAVE** on the screen.

- The Save screen is displayed.

2. Display the video where you want to begin displaying the object or text.

- "IN" blinks.
- Display the video by controlling the player control icon at the bottom left of the screen.

3. Click **SAVE** on the screen.

- This sets the display start position.
- "OUT" starts to blink.

4. Display the video where you want to stop displaying the object or text.

- Display the video by controlling the player control icon at the bottom left of the screen.

5. Click the **AUTO DISP** on the screen.

- This sets the display end position.
- The characters or pictures are saved in the player's memory.
- The group and step where they are saved are shown.

6. Click **EXIT**.

- The Blackboard screen is displayed again.

NOTE:

- By saving the characters and drawing without playing a disc, the drawing can be displayed in a desired scene. (See page 80-81 for executing method.)
- Stored data is not erased even if power to the unit is switched OFF.

NOTE:

- With a DVD, the start point (IN) and end point (OUT) can be set only within the same title. The time display of the IN and OUT points will be shown in () or []. In some cases the image may not be saved exactly as they are in the original.

- The Direction buttons () and on the remote control unit can also be used for the above operation.

DVD

Details on the blackboard

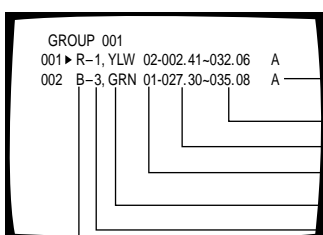

- Display mode (See next page)
 - Display end min.sec.
 - Display start min.sec.
 - Display title
- RED : Red
 - BLU : Blue
 - GRN : Green
 - YLW : Yellow
 - WHT : White
 - BLK : Black
 - GRY : Gray
 - PUR : Purple
- 1 : Line width fine
 - 2 : Line width medium
 - 3 : Line width thick
 - i : Painted inside
 - o : Painted outside
 - L : Line
 - B : Box
 - R : Round

Indicator on the top of right

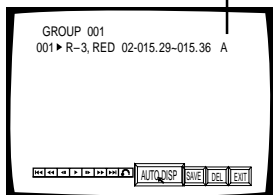





DVD

To change the display mode

1. Move the cursor to the line you want to change and click the left button of the mouse.
2. Move the cursor to  and click the left button of the mouse.

Indicator display on the right edge of screen



- A : Displayed at the same time as the disc playback, from the set start point through the set end point.
- A S : The video becomes a still image at the set start point.
- A S : The video becomes a still image immediately before the set start point.
- No display : The set characters or pictures are not displayed.
Pressing  in this section starts drawing.
- S : The video becomes the still image at the set start point but objects are not displayed.
Press  on the remote control unit to start picture drawing.
- * : The * mark is displayed on the top right of the screen during playback.
Pressing  in this section starts drawing.
- * S : The video becomes a still image, in which only the * mark is displayed, at the set start point.
Press  on the remote control unit to start picture drawing.

Meaning of displayed symbols

- “S” stands for “Still image” and plays a still image at the IN point.
- “A” stands for “Auto display”, which displays drawing in the screen set with AUTO DISP.
- “*” displays only the * marking.
- “_” displays a still image immediately before the start of the IN point.

DVD

Pencil tool/freehand drawing

Click the right button of the mouse in the video blackboard input screen to turn the pointer into the pencil tool. Freehand drawing is possible by holding the mouse's left button. Clicking the right button again displays the Blackboard screen. To change the color or line width, select  or  the tool on the Blackboard screen. (See “Drawing Tools” on page 77.)

NOTE:

- Pictures can be drawn using the pencil tool but they cannot be saved later.

Notes

- It takes time to draw a graphical image, so if you are using it to hide part of the video image, the image-drawing IN point must be set sufficiently in advance of the desired scene. Drawing time varies according to the type of drawn graphic and the number of drawings. As a rule of thumb, the drawing time is usually in the range of 10 to 30 frames.
- If different graphics are recorded in adjacent frames, they may not be drawn on the screen during continuous playback due to drawing speed constraints.
- Operation will not be performed according to the setting during frame reverse or reverse playback.

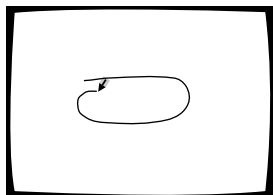

Draw by dragging with the left button pressed.

Grouping video blackboards

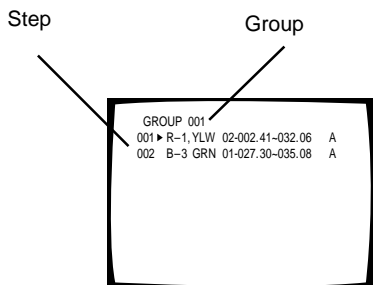

Select the group

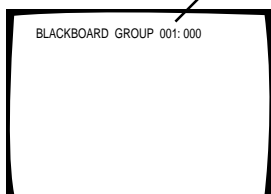

Select the step

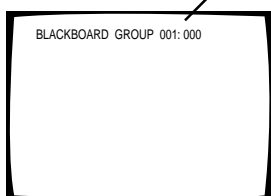

NOTE

The system cannot enter this mode during display of the player control panel.

www.liveline.be

DVD

Grouping blackboards

Blackboards can be registered by dividing them into groups according to the disc and title to enable selective use later.

This makes it possible to store drawn characters and pictures in positions matching the played images.

Pictures and characters comprising groups are also stored as steps.

When executing the blackboards, arbitrary registered blackboard groups can be selected and displayed. Groups also can be deleted.

Selecting a group is done as follows.

When "DISPLAY AREA IN OUT" is displayed on the screen or when the ▶ (pointer) is displayed to the left of **GROUP**, the group that you want can be selected by clicking on the **NEXT** or **PREV** display with the mouse.

The group can be entered by selecting it and clicking on  on the screen.

DVD

To select the group

1. Press twice.

- The step section blinks.
- The step section should continue displaying 000.
- When the step is 000, the entire group will be executed.
- When a step is selected, only the selected step in the group will be executed.

2. Press .

- Group part blinks.

3. Input the number of the group to be recalled/ executed using the numeric buttons.

4. Press twice.

- This starts execution according to the selected blackboard.

DVD

To execute steps in a group

1. Press twice.

2. Press if you want to switch the group.

- If you do not want to change the group, go to step 5 below.

3. Input the number of the group to be recalled/ executed using the numeric buttons.

4. Press .

5. Input the number of the step to begin execution using the numeric buttons.

6. Press .

- This starts execution of the selected step in the selected group.
- The step setup is released after the step has been executed.

Select the step

Select the group

GROUP 001			
001	▶ R-1, YLW 02-002.	41-032.06	A
002	B-3, GRN 01-027.	30-035.08	A

DVD

Recalling/executing previously input blackboards while observing their list

1. Press **RECALL** twice.

2. Press **DISPLAY**.

- This displays a list of commands.

3. Select a group by pressing **PREV** **NEXT**.

4. Select a step by pressing **▲** **▼**.

5. Press **ENTER**.

NOTE

Press **CLEAR** to clear the characters or pictures being displayed. However, characters and pictures that have been set with the

AUTO DISP cannot be cleared with **CLEAR**.

Example

→ Time Flow

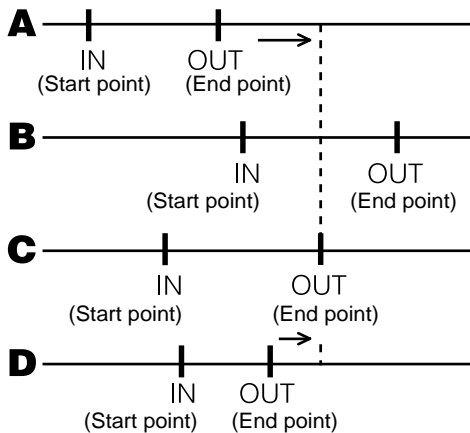

Display of the recalled characters and pictures

Characters and pictures recalled by "Executing an entire group" are not displayed in the order they were registered but in order of the locations of the set display start points. When a character or picture is displayed while another character or picture is already displayed, the newly displayed character/picture is superimposed above the existing character/picture, and all characters/pictures are displayed until the last display end point among the set display end points.

- When pictures A and B are displayed, picture B appears after the display of picture A has ended.
- When pictures A and C are displayed, picture C appears above picture A which is already displayed, and the display of pictures A and C ends at the picture C end point.
- When pictures C and D are displayed, picture D appears above picture C which is already displayed, and the display of pictures C and D ends at the picture C end point.

Video text retrieval

DVD

This player enables playback of text files recorded on DVD Video discs.

With the Video Text Retrieval function, you can use the mouse to click on buttons displayed during DVD Video disc playback. This provides text file indications corresponding to the button, either separately displayed on-screen or superimposed over a DVD still image.

- The Video Text Retrieval function operates with Video Text Retrieval compatible discs. It does not operate with regular DVDs that do not feature recorded text files.
- Video Text Retrieval is our original format.

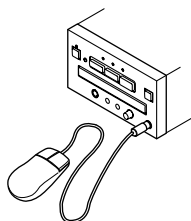
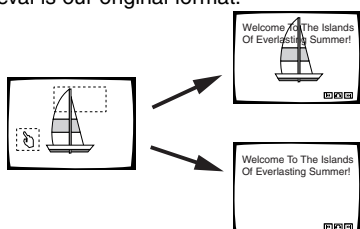

NOTE:

When you return to DVD Video playback after text file display, playback resumes from where you clicked on the button.

External synchronizing function

DVD

To turn on this this function, set the EXTERNAL SYNC option under the ADV. SETUP menu to OFF, and then set either NTSC or PAL according to the type of disc to be played. Further, select NTSC or PAL of the TV SYSTEM selector on the rear panel depending on the disc which is to be played.

Through external input of a synchronization signal (black burst), video output signals can be synchronized with external signals on the DVD-V7300D. (During DVD disc playback.)

Through the use of this function, video switch timing can be matched, and switching can be done without causing picture disturbance on the TV without the need for such devices as a TBC (Time Base Collector).

Synchronized use of 2 or more players

- Using a single sync generator to synchronize two or more players
- Make sure that the terminator switch is ON on the terminal player and OFF on the other players.
- When applying synchronization to one player, set the terminator switch to ON.

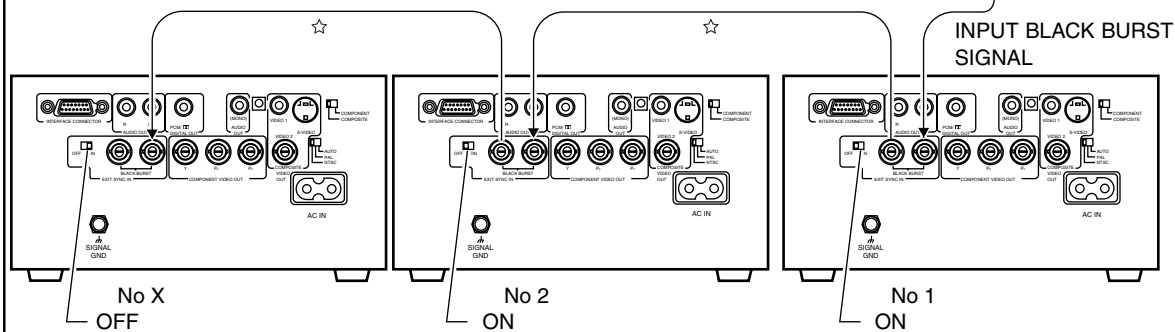
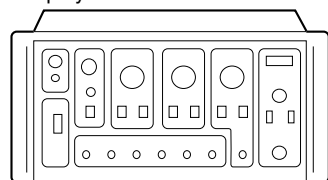

☆ Cables can be found at your local audio/video dealer.

NOTE:

- When the external synchronizing function is turned on, discs other than DVD cannot be played.
- Locking to the sub carrier element of the black burst signal will not occur.
- During the approximately 5 seconds needed for locking to the external synchronizing signal, there will be video disturbance at the video output jacks.
- Input the external synchronizing signal before playback of the DVD disc. Synchronization will not operate if input is done after playback is started.
- In cases where two or more DVD-V7300D units are externally synchronized and their videos are started simultaneously for frame-synchronous playback, turn off AV SYNC COMPENSATE on the ADV. SETUP menu. The external sync function works only with DVD play; it does not work with any other operation.

How to display total hours played and power on time

DVD Video CD CD

This unit is capable of displaying the total play time and power ON time as the working condition and maintenance timing information.

The play time and power ON time can be displayed as described below.

1. Press and hold  on the front panel of the main unit before turning power ON, and press .

2. The screen shows the following:

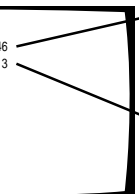
OPERATING TIME		
POWER ON	00105:46	
PLAY	00078:13	

Power on time, which is 105 hours 46 minutes in this example.

Total play time, which is 78 hours 13 minutes in this example.

3. When an operation (playback from the remote, for example) is performed, the time information display disappears and normal operation starts.

NOTE

- As the time is measured by the CPU clock, the information includes an error of up to 2%.
- This is not capable of turning the total play time and power ON time as the working condition and maintenance timing information to 0.

Connecting the player

Precautions when connecting the player

This player's Analog copy protect technology is copy guarded. If you connect the player to a TV via a VCR, or record and playback the contents of a disc with a VCR, the playback picture may not be normal.

Video output

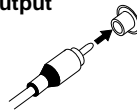

Audio output

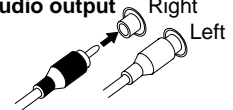

- Connect plugs to the terminals that match the plug's color (white, red, yellow).

Interface connector (RS-232C)

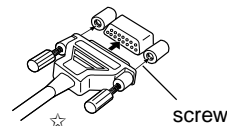

- Align the plug with the connector in the proper orientation and insert, then tighten the lock screws.

S-video output

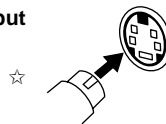

- Connect the TV with S-VIDEO terminal to the S-VIDEO output terminal of this player.

External Sync input (BNC)/Video output (BNC)/Component video output (BNC)

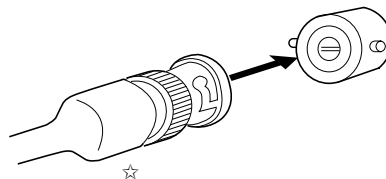

- Align the plug properly with the tab on the connector, and press in carefully, then rotate to the right to lock.

☆ Cables can be found at your local audio/video dealer.

Connecting the player

TV SYSTEM selector

Video output changes as follows according to the playback disc's recorded format.

NTSC-PAL, PAL-NTSC conversion is possible on Video CDs. PAL-NTSC conversion is not possible on DVDs. When the TV SYSTEM selector is set to the AUTO position, the disc's format will be output as is. When a CD or disc is not loaded, the previous video output will be selected.

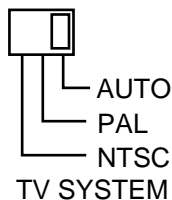

Disc		Output format		
Type	Format	Position of TV SYSTEM selector		
		NTSC	PAL	AUTO
DVD	NTSC	NTSC	MOD. PAL	NTSC
	PAL	—	PAL	PAL
Video CD	NTSC	NTSC	MOD. PAL	NTSC
	PAL	NTSC	PAL	PAL
CD, No disc		NTSC	PAL	NTSC or PAL

About MOD. (Modulation) PAL

Most model of the newly developed countdown PAL TV system detect 50 Hz (PAL)/60 Hz (NTSC) and automatically switch vertical amplitude, resulting in a display without vertical shrinkage. On some TVs, the picture may shrink vertically, leaving black bands at the top and bottom of the screen. This is not malfunction; it is caused by the NTSC-PAL conversion.

If your PAL TV does not have a V-Hold control, you may not be able to view NTSC disc because the picture may roll. If the TV has V-Hold control, adjust it until the picture stop rolling.

Connection of mouse and keyboard

A commercially available PS/2 mouse or PS/2 keyboard can be connected to this unit's mouse/keyboard connector as follows.

1. Turn this unit's POWER off to set it to the standby mode.
2. Connect the PS/2 mouse or PS/2 keyboard to this unit's mouse/keyboard connector.
3. Turn this unit's POWER ON.

Connection is now complete.

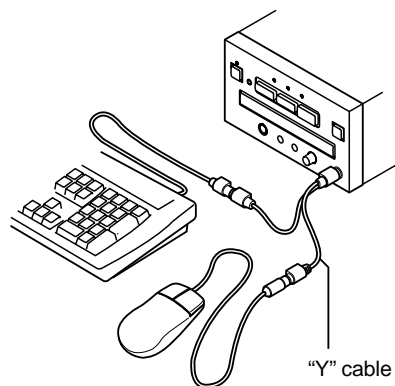

If you want to use both the mouse and keyboard, connect them using a commercially available "Y" cable.

Note:

- The power rating of this mouse/keyboard connector is no more than 5V 100mA. Do not use a mouse or keyboard with a current drain exceeding the rating of 100mA.
- Certain commercially available PS/2 mouse models, PS/2 keyboard models and "Y" cables may not be compatible with this unit. For details, please consult PIONEER technical support.

Connection example 1

- Television (monitor TV)
- Control Computer
- Sync Generator

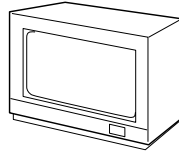

These instructions indicate the connections made when connecting this component directly to a television (monitor TV) to perform disc playback.

● Please also refer to the manual for the TV (monitor TV) that you are connection to.

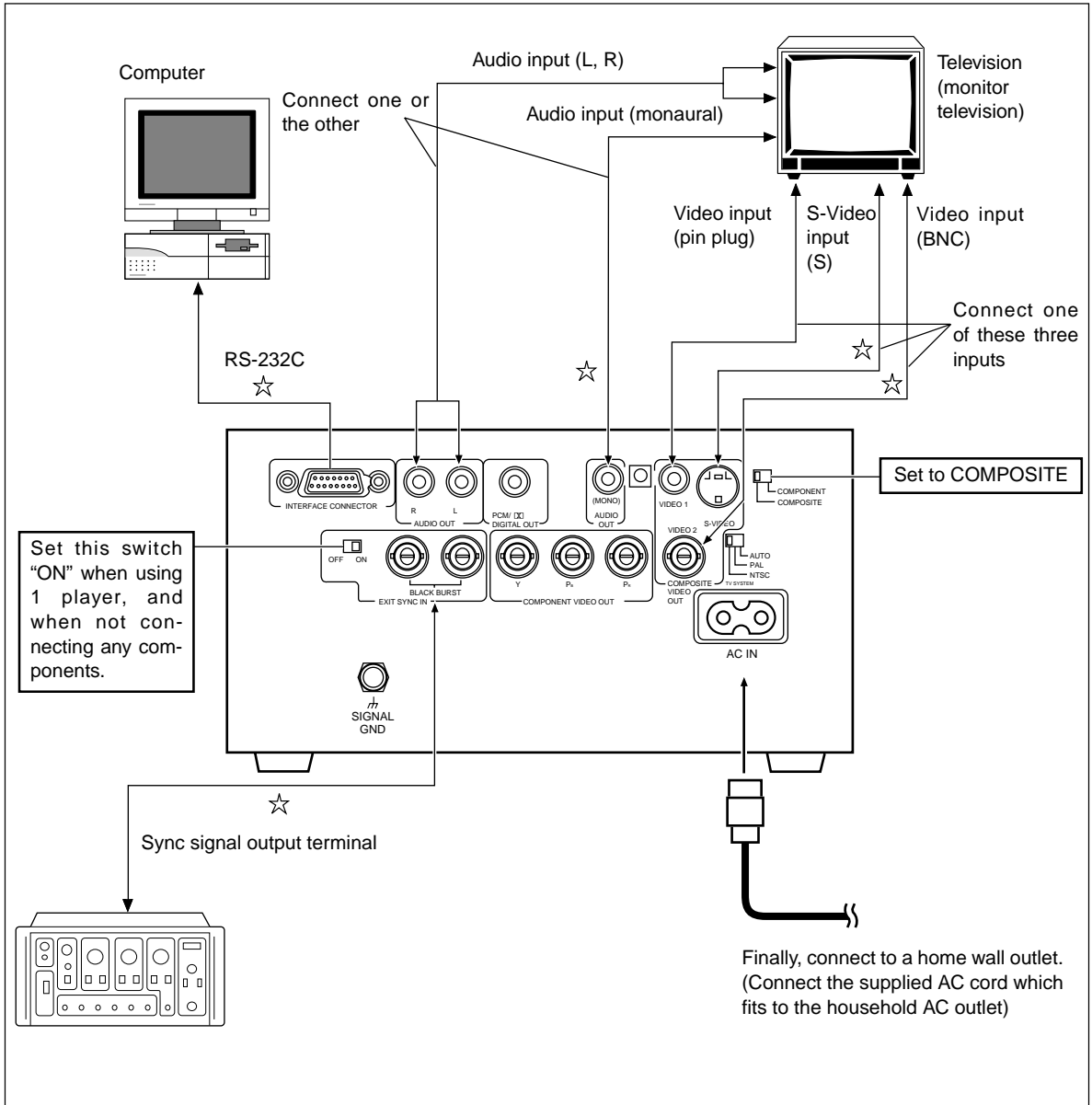

Connect to the Component Video input

- The description of the component video input connectors may differ depending on the TV set or monitor.
- If the color of the picture is thin or something wrong, adjust the color setting of the TV you are connection to.

Do not connect to the component video input of the high-vision TV (Y, P_B, P_R).

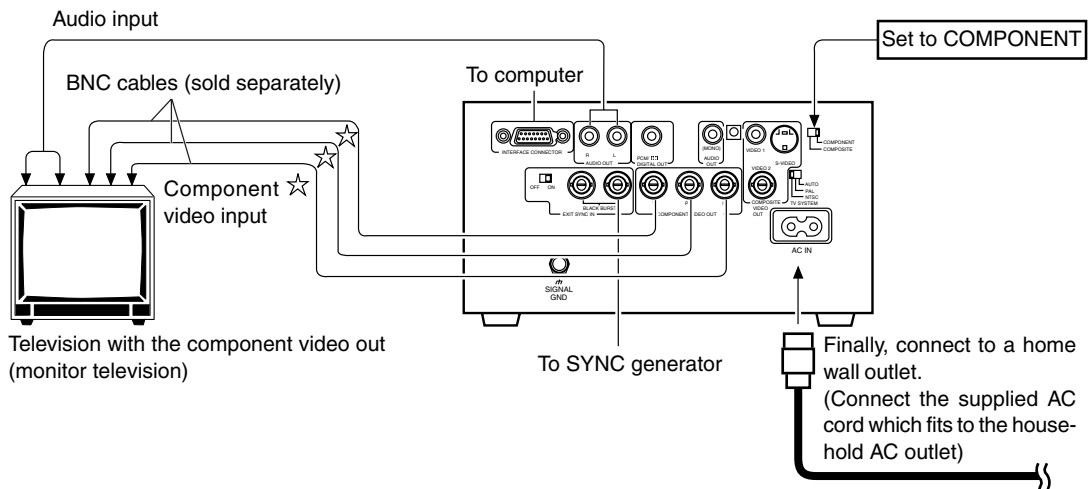

☆ Cables can be found at your local audio/video dealer.

Connection example 2

AV receiver with digital input for Dolby Digital.



When connecting the player to an amplifier with Dolby Digital inputs.

*Make this connection when using this unit with Pioneer's VSA-E06, VSA-E07 AV amplifier.

- Connect this unit's digital output PCM/  jack to the Dolby Digital input jack of a Dolby Digital compatible amplifier.
- Select whether or not to use the coaxial digital output according to the amplifier's input jack.

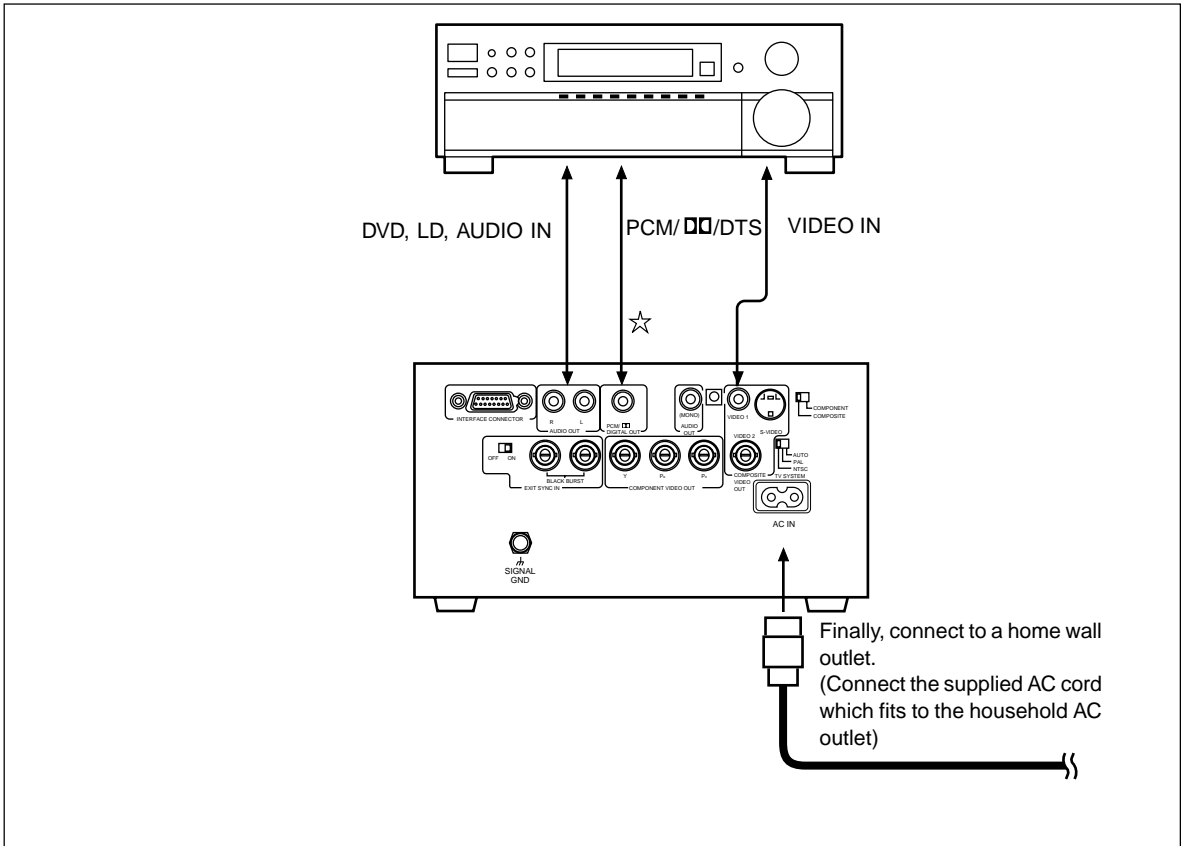

☆ Cables can be found at your local audio/video dealer.

- Some discs may not allow digital output when this player's output down sampling is set for 96 kHz (see page 41).

Connection example 3

AV amplifier

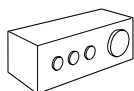

By connecting to a regular AV amplifier or stereo amplifier, you can enjoy playback with improved sound quality.

- Connect this player's audio output jacks to an amplifier's CD, LD, AUX or other audio input jacks. (Do not connect to PHONO jacks.)
- Connect this player's video output jack to the amplifier's video input jack.

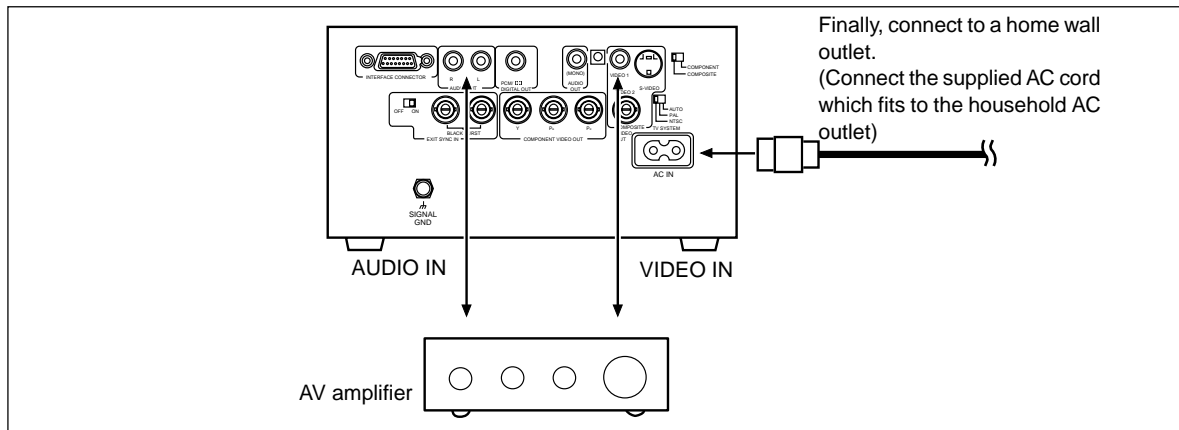

- Surround sound can be enjoyed with amplifiers that have a built-in Dolby Pro Logic decoder.
- For more details, refer to the connected component's operation manual

Connection example 4

Digital Audio recorder

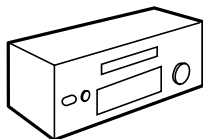

You can connect to a digital audio recorder as MD, CD-R or DAT.

- Connect this player's coaxial digital output jacks to MD player, CD-R player, or DAT player.
- Connect this unit's digital output PCM/  jack to the digital audio recorder.

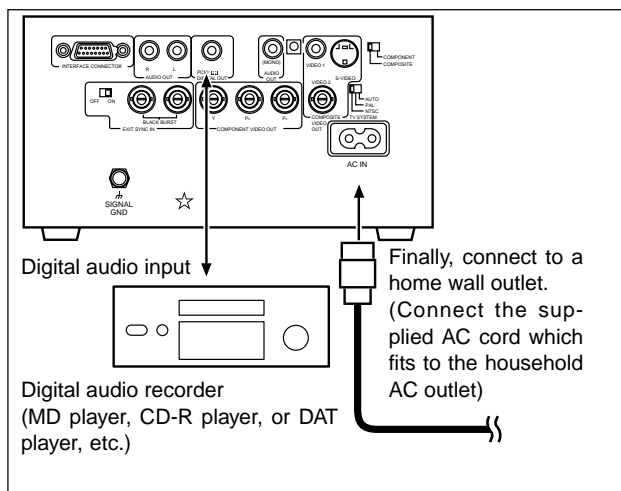

NOTE

When you record the Dolby Digital DVD, set [Digital Output] (see page 34) to [Dolby Digital▶PCM]. If [Digital Output] is set to [Dolby Digital] during recording Dolby Digital DVD, noise is recorded.

☆ Cables can be found at your local audio/video dealer.

Using a Laser Barcode Scanner (Sold Separately)

Laser Barcode Scanner

To use the optional LaserBarcode Scanner (UC-V108BC or UC-V109BC) in the wired mode to transmit signals, connect the LaserBarcode scanner's connection cord to the player's front-panel EXT.CONT jack.

To transmit barcode signals in the wireless mode, aim the remote control unit toward the player's remote control signal receiver. Consult the LaserBarcode Scanner's Operating Instructions for details on operation.

Note:

- During operations using the LaserBarcode Scanner, attempting to operate the player by means of the remote control unit, player operating buttons, or serial commands from a computer may cause malfunctions.
- When using the LaserBarcode Scanner in the wired mode, the remote control unit is disabled in order to prevent error commands from the remote control unit. For this reason, it is recommended that the wired mode be used.
- When the player is operated via barcodes, the on-screen displays when this player is operated such as "Play" and "Stop" do not appear.
- When a CD or Video CD disc is loaded, barcode commands issued for LD or DVD are ignored.
- When a DVD is loaded, commands issued for CDs are ignored.

When used in wireless mode:

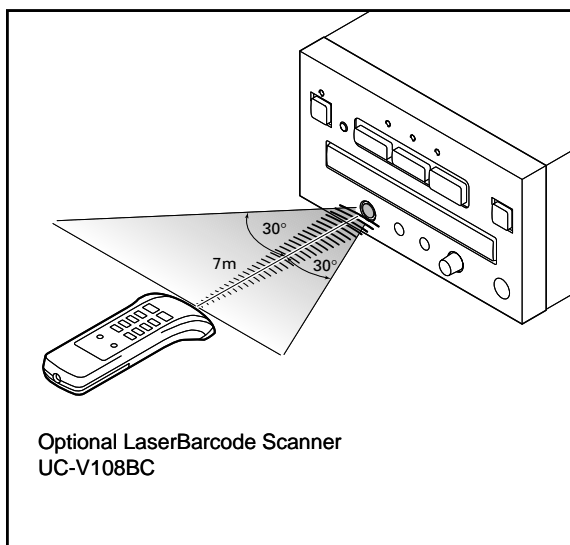

When used in wired mode:

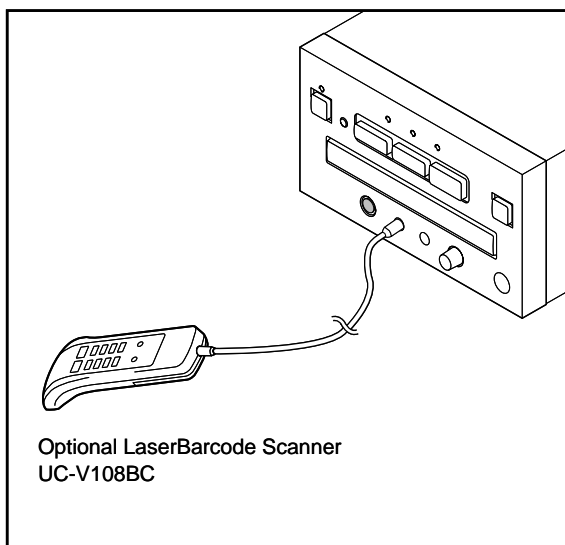

Troubleshooting

If you are wondering whether you have a breakdown, please check and find out. A slight mistake in operation can make you think that you have a breakdown. Furthermore, factors other than this player can also be considered. Check the television, the AV amplifier and the speakers, etc., that you use together with this player. When the problem is not corrected, even after inspecting again according to the items below, contact the store where you purchased the player or the nearest PIONEER authorized service center.

Power does not come on.

➔ Connect the power cord to the outlet properly (page 86 - 89).

Even when the disc table is closed, it comes out.

➔ Set the disc in the disc table properly (page 16).

➔ Clean the disc (page 8).

➔ Check the region no. (page 13, 91).

The screen does not appear.

➔ Check the setting of the video output selector at the rear of this player with the connected video terminal (page 85, 86).

➔ Confirm that connections are correct (page 83-88).

➔ Make the television or AV amplifier setting, etc., to DVD playback setting.

Cannot play back.

➔ Clean the disc (page 8).

➔ Set the disc in the disc table properly (page 16).

➔ Remove the condensation in the player (page 8).

➔ SECAM format discs cannot be played back.

➔ Insert the disc with the proper side up.

The contents of the settings disappear.

➔ When the power has been turned off due to a power outage and the power cord having been pulled out while the power is turned on, the contents of the settings disappear. Make sure to pull out the power cord after the power button of the player or the power button of the remote control has been pressed and the indicator has turned orange.

The screen stops and the operation buttons are not accepted.

➔ After pressing  ^{STOP}, play back once more.

The mark appears on the screen.

➔ The disc prohibits that operation (page 13).

The mark appears on the screen.

➔ The player prohibits that operation (page 13).

Cannot use the remote control.

➔ Operate within the usage range of the remote control. (page 16)

➔ Replace the dry cell batteries of the remote control with new ones (page 5).

External synchronizing cannot be performed.

➔ Refer to the EXTERNAL SYNC setting in the ADV. SETUP menu. (page 48)

➔ Check the notes under "NOTE" for the external synchronizing function. (page 82).

No sound comes from the speakers or the sound is distorted

➔ Confirm that the audio cable is properly connected (pages 83-88).

➔ Some discs prohibit 96 kHz digital output of Linear PCM audio. With these kinds of discs, even if the [96 kHz PCM Out] setting of [Audio 1] of the setup menu screen is set to [96 kHz], it is automatically changed to 48 kHz and output. (page 41).

➔ During playback of a DVD recorded at 96 kHz in 16:9, when [4:3 (Letter Box)] of [Video] is selected, even if the setting of [96 kHz PCM Out] of [Audio 1] is set to [96 kHz], it is automatically changed to 48 kHz and output (page 29).

➔ Clean the disc (page 8).

➔ If it has been set to the pause or slow playback mode, change to the playback mode (page 21).

➔ If the volume of the television or AV amplifier, etc., has been set to "minimum", raise the volume.

➔ Confirm that the connector plug has been sufficiently inserted and that it has not been disconnected.

➔ If the connector plug and terminal are dirty, wipe them.

The screen is extended vertically or horizontally.

➔ Adjust the [TV Screen] setting (page 30).

There are difference in volume between DVD and CD.

➔ This is due to the difference in the disc recording methods.

The picture is distorted or dark during DVD playback

➔ This player has the copy guard of an analog copy protect system. Some discs have a copy prohibition signal. When those types of discs are played back, a condition such as lateral stripes on part of the screen appears, but this is not a malfunction.

The playback screen is distorted when a DVD video has been recorded on a VCR and played back on a VCR

➔ This player has the copy guard of an analog copy protect system. Some discs have a copy prohibition signal and when that kind of disc is played back on a VCR, and recorded and played back on a VCR, it cannot be played back normally due to the copy guard.

The television, etc., malfunctions

➔ Some televisions with a wireless remote control function malfunction due to the remote control of this player. Use them separated from this player.

When setup menu screen appears, a screen set to letter box suddenly becomes extended vertically.

➔ When setup menu screen appears during playback in the letter box or pan & scan modes, the screen size is forcibly changed to the wide-screen mode, but this is not a malfunction. (See page 30)

This player may not operate normally due to outside influences such as static electricity. At such times it may operate normally after the power cord has been temporarily unplugged and plugged in again. When the problem has not been solved by this procedure, consult the store where you purchased the player or the nearest service station.

Terms

Aspect

Aspect ratio refers to the length to height ratio of TV screens. The ratio of a normal TV is 4:3, while the ratio of a Hi-vision TV or wide TV is 16:9. This allows you to enjoy a picture with a wider perspective.

Component video output

The color signal of the TV is divided into the luminance (Y) signal and the color (P_B and P_R) signals and then output. In this way mutual interference of each signal is avoided. On a TV with component input jacks, these signals are synthesized to produce the picture.

Parental level

This function was suggested by parents. Parental level control are restrictions incorporated into scenes that allow parents to prevent their children from viewing them if they desire.

Dynamic range

Dynamic range refers to the difference between the maximum and minimum levels of the audio soundtrack as measured in decibels (dB).

Dolby Digital

The maximum 5.1 channels of audio used in the surround system (Surround Digital) for movie theaters is digital data compressed by AC-3.



For DVD discs, the digital output PCM/  jack must be connected to the amplifier or processor's digital input AC-3/PCM jack.

Playback Control (PBC)

This refers to signals recorded on a Video CD (Version 2.0) enabling playback control.

You can use menus recorded on discs with PBC for easy, interactive search for desired scenes and playback.

You can also enjoy viewing high-resolution/standard resolution still images.

Multi-angle

When you watch regular TV programs you are watching the image filmed through the TV camera. Because of this, the picture is displayed on your TV from the view point of the TV camera's position. In a TV studio the image is filmed by many cameras at the same time. One of those images is selected by the program director and transmitted to your TV. If all the filmed images were transmitted to your TV you would be able to select the camera image you want. Some DVD discs are recorded with the angles of all the camera's used for filming and you can select among them when using this player. These types of discs are called multi-angle discs.

Multi-audio

Some DVD has multi audio language.

Up to eight different languages (8 streams) can be recorded on a DVD disc, The multi audio function can be used to select the language of your choice.

Subtitle

Subtitles are language titles superimposed on movies etc. Up to 32 different subtitle languages can be recorded on a DVD disc. The subtitle function can be used to select the language of your choice.

Regional restriction codes (Region number)

Regional restriction codes are built in to DVD players and DVD discs for each sales region. If the regional restriction codes of the DVD player does not match one of the regional restriction codes of the DVD disc, playback is not possible.

The regional restriction code can be found on the rear panel of the DVD player. The illustration below shows the regions and corresponding region numbers.

Linear PCM

This refers to DVD audio recording format. It is the same format as that of CD audio, but the sampling frequency is recorded at 48 kHz and 96 kHz, and audio with a higher sound quality than that of a CD can be enjoyed.

DTS

DTS stand for Digital Theater System. DTS is a surround system different from Dolby Digital that has become a popular surround format for movies.



MPEG

MPEG stand for Moving Picture Expert Group. This is an international standard for compression of moving images. On some DVDs, digital audio has been compressed and recorded in this format.

PCM

PCM stands for Pulse Code Modulation and is digital audio. The digital audio of CD or DVD discs is PCM.

5.1 ch

This refers to multi-channel audio with a special low sound range 0.1 channel added to the five channels of front left/right, center and rear left/right. It is used by the Dolby Digital and DTS surround systems.

Specifications

General

System	DVD system and Compact Disc digital audio system
Power requirements	AC 220-240 V, 50/60 Hz
Power consumption	15 W
Power consumption in standby mode	0.8W
Weight	4.5 kg
Dimensions	210 (W) x 412 (D) x 119 (H) mm (Not including protruding cables, etc.)
Operating temperature	+5°C to +35°C
Operating humidity	No more than 85% (no condensation)

Video Output

Output level	1 Vp-p (75Ω when loaded, synchronous negative)
Jacks	BNC, RCA

S-Video Output

Y (luminance) - Output level	1 Vp-p (75Ω)
C (color) - Output level	286 mVp-p (75Ω)

Component video Output

Y - Output level	1 Vp-p (75Ω) BNC
P _B - Output level	0.7 Vp-p (75Ω) BNC
P _R - Output level	0.7 Vp-p (75Ω) BNC
S/N ratio	more than 60 dB
Horizontal resolution	more than 500

External synchronizing input

Input signal level	Black burst 0.3 Vp-p (75Ω) BNC x 2 (loop through)
--------------------------	--

Audio Output

Output level	
During audio output	200 mVrms (1 kHz, -20 dB)
Number of channels	2
Frequency response	4 Hz to 22 kHz (DVD fs: 48 kHz) 4 Hz to 20 kHz (CD)
S/N ratio	115 dB (EIAJ)
Dynamic range	98 dB (EIAJ)
Wow and flutter	±0.001% W. PEAK or lower (EIAJ)

Other Terminals

Coaxial digital output	RCA jack
Communication interface	D-SUB, 15-pin

Accessories

Audio cord	1
Video cord	1
AC cord	2
Remote control unit	1
AA (R6P) dry cell batteries	2
Laser barcode sheet	1
Operating Instructions	1

NOTES:

- All values listed in these specifications are standard values.
- The specifications and design of this product are subject to change without notice, due to improvement.

Français

Caractéristiques techniques

Généralités

Système	DVD et Compact Disc Digital Audio
Alimentation	220-240 V, 50/60 Hz
Consommation	15 W
Consommation en veille	0,8 W
Poids	4,5 kg
Dimensions	210 (W) x 412 (P) x 119 (H) (Non compris les parties saillantes, câbles, etc.)
Température de fonctionnement	+5°C à +35°C
Humidité ambiante	Inférieure à 85% (sans condensation)

Sorties vidéo

Niveau de sortie	1 Vc-c (75 Ohms, négatif synchrone)
Prises	BNC, RCA

Sorties S-vidéo

Niveau de sortie de la luminance (Y)	1 Vc-c (75 Ohms)
Niveau de sortie de la chrominance (C)	286 mVc-c (75 Ohms)

Sortie des vidéo component

Niveau de sortie de Y	1,0 Vc-c (75 Ohms) BNC
Niveau de sortie de P _B	0,7 Vc-c (75 Ohms) BNC
Niveau de sortie de P _R	0,7 Vc-c (75 Ohms) BNC
Rapport signal/bruit	plus de 60 dB
Définition horizontale	plus de 500

Entrée de synchronisation externe

Niveau du signal d'entrée	Salve noir 0,3 Vp-p (75Ω) BNC x 2 (en boucle)
---------------------------------	--

Sortie audio

Niveau de sortie	
Niveau de sortie numérique	200 mV eff. (1 kHz, -20 dB)
Nombre de voies	2
Réponse en fréquence ...	4 Hz à 22 kHz (Fs de DVD: 48 kHz) 4 Hz à 20 kHz (CD)
Rapport signal/bruit	115 dB(EIAJ)
Dynamique	98 dB(EIAJ)
Taux de pleurage et de scintillement	±0,001% crête, pondéré, ou moins (EIAJ)

Autres prises

Sortie coaxiale	RCA
Interface de communication	D-SUB, 15 broches

Accessoires

Cordon audio	1
Cordon vidéo	1
Cordon d'alimentation	2
Télécommande	1
Piles sèches AA/R6P	2
Feuilles de barres codes laser	1
Mode d'emploi	1

Remarque:

- Toutes les valeurs indiquées dans ces caractéristiques techniques sont des valeurs standards.
- Les caractéristiques et la présentation peuvent être modifiées sans avis préalable à fin d'amélioration.

Technische Daten

Allgemeines

System	DVD-System und digitales Compact Disc-Audiosystem
Stromversorgung	220 - 240 V Wechselspannung, 50/60 Hz
Leistungsaufnahme	15 W
Leistungsaufnahme im Bereitschaftsmodus	0,8 W
Gewicht	4,5 kg
Abmessungen	210x 412 x 119 mm (B x T x H) (Ausschließlich hervorstehender Kabel usw.)
Betriebstemperatur	+5°C bis +35°C
Luftfeuchtigkeit bei Betrieb	85% maximal (ohne Kondensationsbildung)

Video-Ausgang

Ausgangsspegel	1 Vs-s (75 Ω, negative Synchronisation)
Anschlußbuchsen	BNC, RCA-Buchsen

S-Video-Ausgang

Y (Leuchtdichte) - Ausgangsspegel	1 Vs-s (75 Ω)
C (Farbsignal) - Ausgangsspegel	286 mVs-s (75 Ω)

Komponentensignal-Videoausgang

Y - Ausgangsspegel	1 Vs-s (75 Ω) BNC
P _B - Ausgangsspegel	0,7Vs-s (75 Ω) BNC
P _R - Ausgangsspegel	0,7Vs-s (75 Ω) BNC
Signal/Rauschabstand	mehr als 60 dB
Horizontalauflösung	mehr als 500

Eingang für externe Synchronisation

Eingangssignalpegel	Schwarzburst 0,3 Vs-s (75 Ω) BNC x 2 (durchgeschleift)
---------------------------	---

Audio-Ausgang

Ausgangsspegel	
Bei Audio-Ausgabe	200 mVrms (1 kHz, -20 dB)
Anzahl der Kanäle	2
Frequenzgang	4 Hz bis 22 kHz (DVD fs: 48 kHz) 4 Hz bis 20 kHz (CD)
Signal/Rauschabstand	115 dB (EIAJ)
Dynamikbereich	98 dB (EIAJ)
Tonhöenschwankungen	±0,001% W. PEAK oder niedriger (EIAJ)

Andere Anschlüsse

Koaxialer Digital-Ausgangsanschluß	RCA-Buchse
Kommunikations-Schnittstelle	15polige D-SUB-Buchse

Zubehör

Audiokabel	1
Videokabel	1
Netzkabel	2
Fernbedienungseinheit	1
Trockenzellenbatterien AA (R6P)	2
Laser-Strichcodeblatt	1
Bedienungsanleitung	1

Hinweis

- Bei den obigen Angaben handelt es sich um die Standardwerte.
- Die technischen Daten und das Design dieses Produkts können aus Gründen der Weiterentwicklung ohne vorherige Ankündigung geändert werden.

Dati tecnici

Generali

Sistema	DVD e audio digitale per CD
Alimentazione	A c.a. a 220 - 240 V, 50/60 Hz
Consumo	15 W
Consumo nel modo di attesa	0,8 W
Peso	4,5 kg
Dimensioni	210x 412 x 119 (L x P x A) senza protrusioni
Temperatura di lavoro	Da 5°C a 35° C
Umidità di lavoro	Non più dell'85%, senza condensa

Uscite video

Livello di uscita	1 Vp-p (75 ohm, Negativo sincrono)
Prese	BNC, RCA

Uscite S-video

Y (luminanza) - livello di uscita	1 Vp-p (75 ohm)
C (colore) - livello di uscita	286 mVp-p (75 ohm)

Uscite video componente

Y - livello di uscita	1 Vp-p (75 ohm), BNC
P _B - livello di uscita	0,7Vp-p (75 ohm), BNC
P _R - livello di uscita	0,7Vp-p (75 ohm), BNC
Rapporto S/R	oltre 60 dB
Risoluzione orizzontale	più di 500

Ingresso esterno di sincronizzazione

Livello del segnale in ingresso	A raffiche nero 0,3 Vp-p (75ohm) BNC x 2 (anello passante)
---------------------------------------	---

Uscita audio

Livello di uscita	
Audio	200 mVrms (1 kHz, -20 dB)
Numero di canali	2
Risposta in frequenza	da 4 Hz a 22 kHz (freq. campionamento DVD: 48 kHz) da 4 Hz a 20 kHz (CD)
Rapporto S/R	115 dB (EIAJ)
Gamma dinamica	98 dB (EIAJ)
Wow & flutter	±0,001% a vtaggio di picco (EIAJ)

Altri terminali

Uscita digitale coassiale	Presca RCA
Interfaccia di comunicazione	D-SUB a 15 pin

Accessori

Cavo audio	1
Cavo video	1
Cavo di alimentazione	2
Telecomando	2
Batterie a secco AA (R6P)	2
Foglio con codice a barre al laser	1
Istruzioni per l'uso	1

Note

- Tutti i valori elencati in questi dati tecnici sono valori standard.
- Il design ed i dati tecnici di questo prodotto sono soggetti a modifiche senza preavviso.

Especificaciones

Generalidades

Sistema	Sistema de DVD y sistema de audio digital de disco compacto
Alimentación	CA 220-240 V, 50/60 Hz
Consumo	15 W
Consumo en el modo de espera	0,8 W
Peso	4,5 kg
Dimensiones	210 (An) x 412 (Prof) x 119 (Al) mm (Sin incluir cables que sobresalgan, etc.)
Temperatura de funcionamiento	+5°C a + 35°C
Humedad de funcionamiento	No más del 85% (sin condensación)

Salida de vídeo

Nivel de salida	1 Vp-p (75 Ω, sincronización negativa)
Tomas	BNC, RCA

Salida de S vídeo

Y (luminancia) - Nivel de salida	1 Vp-p (75 Ω)
C (color) - Nivel de salida	286 mVp-p (75 Ω)

Salida de Component vídeo

Y - Nivel de salida	1 Vp-p (75 Ω), BNC
P _B - Nivel de salida	0,7 Vp-p (75 Ω), BNC
P _R - Nivel de salida	0,7 Vp-p (75 Ω), BNC
Relación señal a ruido	más de 60 dB (EIAJ)
Definición horizontal	más de 500

Entrada de sincronización externa

Nivel de señal de entrada	Ráfaga negra 0,3 Vp-p (75Ω) BNC x 2 (conexión derivada)
---------------------------------	--

Salida de audio

Nivel de salida	
Durante la salida de audio	200 mVrms (1 kHz, -20 dB)
Número de canales	2
Respuesta de frecuencia	4 Hz a 22 kHz (DVD fs: 48 kHz) 4 Hz a 20 kHz (CD)
Relación señal a ruido	115 dB (EIAJ)
Gama dinámica	98 dB (EIAJ)
Fluctuación y trémolo	±0,001% W. PEAK menos (EIAJ)

Otros terminales

Salida digital coaxial	Toma RCA
Interfaz de comunicación	D-SUB, 15 contactos

Accesorios

Cable de audio	1
Cable de vídeo	1
Cable de alimentación	2
Mando a distancia	1
Pilas secas AA (R6P)	2
Hoja de código de barra láser	1
Manual de instrucciones	1

- Todos los valores listados en estas especificaciones son valores estándar.
- Las especificaciones y el diseño de este producto están sujetos a cambios sin previo aviso con motivos de mejoras.

Information about this product

- The German, French, Italian and Spanish versions of this Operating Instructions are in PDF format at the web site below.
- Les versions allemande, française, italienne et espagnole de ce mode d'emploi sont disponibles en format PDF sur le site Internet ci-dessous.
- Versionen dieser Bedienungsanleitung in deutscher, französischer, italienischer und spanischer Sprache stehen im PDF-Format beim unten angegebenen Web Site zur Verfügung.
- Le versioni in tedesco, francese, italiano e spagnolo di queste istruzioni per l'uso sono disponibili nel formato PDF al sito web sotto.
- Las versiones española, alemana, francesa e italiana de estas instrucciones de utilización se encuentran disponibles en formato PDF en el sitio de la telaraña mostrado a continuación.

<http://www.pioneer-eur.com>

France; tapez 36 15 PIONEER

PIONEER CORPORATION

4-1, Meguro 1-Chome, Meguro-ku, Tokyo 153-8654, Japan

PIONEER ELECTRONIC [EUROPE] N.V.

Multimedia Division: PIONEER House, Hollybush Hill STOKE POGES, SLOUGH SL2 4QP UK TEL: 44-1-753-789-789 FAX: 44-1-753-789-880

www.liveline.be

<99K00JF0G00>

Printed in Japan/Imprimé au Japon <DRB1268-A>